

THE CAIRO DAHSHUR BOATS

A Thesis

by

PEARCE PAUL CREASMAN

Submitted to the Office of Graduate Studies of
Texas A&M University
in partial fulfillment of the requirements for the degree of

MASTER OF ARTS

December 2005

Major Subject: Anthropology

THE CAIRO DAHSHUR BOATS

A Thesis

by

PEARCE PAUL CREASMAN

Submitted to the Office of Graduate Studies of
Texas A&M University
in partial fulfillment of the requirements for the degree of

MASTER OF ARTS

Approved by:

Chair of Committee,	Cemal Pulak
Committee Members,	Filipe Vieira de Castro
	James Rosenheim
Head of Department,	David Carlson

December 2005

Major Subject: Anthropology

ABSTRACT

The Cairo Dahshur Boats. (December 2005)

Pearce Paul Creasman, B.A., The University of Maine

Chair of Advisory Committee: Dr. Cemal Pulak

Excavations conducted in A.D. 1894 and 1895 by French archaeologist Jean-Jacques de Morgan at the funerary complex of the ancient Egyptian Middle Kingdom pharaoh Senwosret III on the plain of Dahshur revealed some unparalleled finds which included five or six small boats. These boats provide a unique opportunity in nautical archaeology—to study contemporaneous hulls. Today, only four of the "Dahshur boats" can be located with certainty; two are in the United States, one in the Carnegie Museum of Natural History in Pittsburgh and one in the Field Museum of Natural History in Chicago. The remaining two are on display in The Egyptian Museum, Cairo.

Since their excavation these boats remained relatively inconspicuous until the mid-1980s when a study of the two hulls in the United States was conducted. However, the two boats in Cairo remained largely unpublished.

This thesis combines personal observation and recording of the Cairo boats over two summers to reveal more unique characteristics of the hulls and will facilitate a future study of the group as a whole. Each boat is discussed individually and is further divided into its major components by order of construction.

DEDICATION

To my parents, as they all will be.

ACKNOWLEDGEMENTS

Many people and organizations have contributed to the completion of this work and it is only appropriate that I begin this thesis with thanks to those at the Egyptian Museum, Cairo, who facilitated my research. I would like to thank the Supreme Council on Antiquities and past Director of the museum, Dr. M. Eldamaty, for receiving my original request to study the boats, and returning a favorable response in record time. Dr. Wafaa El Saddek, current General Director, provided interminable support and encouragement throughout my research despite an incident of spontaneous arrival; she deserves more than a simple "thank you." The time and patience of Mme. Salwah, curator of Middle Kingdom artifacts, and curator, Mr. Magdy, was much appreciated, while former-restorer Shima Sadek's humor and confidence provided comfort in several situations that could have otherwise been calamitous. Without the guidance and friendship of curator Waheed Edwar the work and time in Cairo would have proved very difficult, as such I cannot thank him enough.

If not for the support of several institutions this project would have never come to fruition. Primarily, the contributions of RPM Nautical Foundation and Dr. Jeffrey Royal permitted me to take two teams of fellow graduate students to Cairo to assist in my research. The Institute of Nautical Archaeology, its staff, and notably Dr. Donny L. Hamilton, George O. Yamini Chair in Liberal Arts, helped me find my way to Egypt. The L.T. Jordan Institute for International Awareness, specifically Paige Chapman, Diego Garcia, and Carol Galjour, provided for shelter and sustenance while experiencing this small part of Africa. Associate Dean Larry Oliver, of the College of Liberal Arts, came through in a pinch and for his support I am grateful.

The Melbern G. Glasscock Center for Humanities Research and Dr. James Rosenheim were the first to actively support this research and without their help the completion and presentation of this work would not have been possible.

In addition, I would like to thank Dr. Cemal Pulak and Dr. Shelly Wachsmann for taking time to discuss parts of this research that were at times confounding. Dr. Filipe Castro was both provocative and encouraging in his support throughout this process as it was his ship reconstruction course that provided much of the impetus for this thesis.

I would be remiss if I did not thank Lord Falcon for his distractions while writing that permitted me to keep this work in perspective. Also, I need to thank my grandparents—Robert and Yvonne Montgomery and Courtney and Pop Creasman for a lifetime of encouragement and examples.

Finally, I must thank my parents, Clinton and Kay M. Creasman for too many things to mention.

TABLE OF CONTENTS

	Page
ABSTRACT.....	iii
DEDICATION.....	iv
ACKNOWLEDGEMENTS.....	v
TABLE OF CONTENTS.....	vii
LIST OF TABLES.....	ix
LIST OF FIGURES.....	x
INTRODUCTION.....	1
THE MIDDLE KINGDOM, THE 12TH DYNASTY, AND SENWOSRET III.....	15
EGYPTIAN MUSEUM, CAIRO GC 4925 - THE DE MORGAN BOAT.....	25
Dating.....	35
Central Strake.....	37
Hull Planking.....	44
Throughbeams and Deck Planking.....	53
Fastening and Joinery.....	60
Tool Marks.....	65
Steering Arrangement.....	66
Ornamentation.....	70
Surface Decoration.....	72
EGYPTIAN MUSEUM, CAIRO GC 4926.....	74
Dating.....	83
Central Strake.....	83
Hull Planking.....	87
Throughbeams and Deck Planking.....	96
Fastening and Joinery.....	102
Tool Marks.....	106
Steering Arrangement.....	107
Ornamentation.....	110
Surface Decoration.....	113
ANALYSIS.....	116
CONCLUSIONS.....	132

	Page
WORKS CITED.....	134
APPENDIX.....	139
A CHRONOLOGY AND IMPORTANT DATES.....	139
B LINE TRANSLATION OF SELECT PAGES IN <i>FOUILLES Á</i> <i>DÁHCHOUR</i> (1895).....	141
C THE TURIN CANON.....	142
D THE ROYAL TITULARY OF SENWOSRET III.....	143
E BENI HASSAN, TOMB 2/ MAIN ROOM, EAST WALL.....	145
F TABLE OF DECK PLANK MEASUREMENTS FROM GC 4926.....	146
VITA.....	149

LIST OF TABLES

TABLE		Page
1	Central strake dimensions in meters - de Morgan boat.....	37
2	Dimensions of strakes 1, 2, and 3 in meters - de Morgan boat.....	49
3	Dimensions of strake 4 in meters - de Morgan boat.....	50
4	Dimensions of strake 5 (weather strake) in meters - de Morgan boat.....	51
5	Dimensions of throughbeams and rooms in meters - de Morgan boat.....	55
6	Dimensions of deck planking in meters and frequency of pegs and mortises...	58
7	Central strake dimensions in meters - GC 4926.....	85
8	Dimensions of strakes 1, 2, and 3 in meters - GC 4926.....	92
9	Dimensions of strake 4 in meters - GC 4926.....	93
10	Dimensions of strake 5 (weather strake) in meters - GC 4926.....	96
11	Dimensions of throughbeams and rooms in meters - GC 4926.....	98

LIST OF FIGURES

FIGURE		Page
1	Map of ancient Egypt with key sites and regions.....	2
2	Predynastic watercraft on a Naqada II period vessel in the Aswan Museum.....	4
3	Models of daily life—fishing. From the tomb of Meket-Rē.....	6
4	Dahshur boat GC 4925 on display.....	7
5	Site map of the pyramid complex of Senwosret III.....	10
6	Mortise-and-tenons joining port strakes 4 and 5 on GC 4925.....	12
7	Mortise-and-tenon joinery.....	12
8	Dovetails joining port strakes 1 and 2 on GC 4925.....	13
9	Dovetail joinery.....	13
10	Map of the Faiyum region with key sites.....	16
11	Statue head of Senwosret III at the Luxor Museum.....	19
12	First drawings of the de Morgan boat.....	26
13	The de Morgan boat on display, from bow.....	28
14	Excavation photograph of the de Morgan boat.....	30
15	Hull lines for the de Morgan boat.....	31
16	Plank C2 of the de Morgan boat.....	38
17	Plank C1 of the de Morgan boat.....	41
18	Central strake (C3) outboard beveling at stern of de Morgan boat.....	42
19	Plank C3 of the de Morgan boat.....	43
20	S1-3 on the de Morgan boat.....	46

FIGURE	Page
21 Construction plans for the de Morgan boat.....	47
22 Flattened planking plan of the de Morgan boat - not to scale.....	48
23 Section of a throughbeam with treenailed deck planking from the de Morgan boat.....	54
24 Starboard end on throughbeam 4 of the de Morgan boat showing narrowing..	54
25 Interior of the de Morgan boat, from starboard.....	57
26 Dovetail overlapping an ancient mortise on the de Morgan boat.....	63
27 Lashing pattern in the bow of the de Morgan boat.....	64
28 Close up of a cross-hatched impression at a mortise on the de Morgan boat.....	66
29 Blade of a quarter rudder.....	68
30 Stanchions on the de Morgan boat, from stern.....	69
31 A Horus-head carving mounted on the starboard side of the quarter rudder crosspiece.....	71
32 Collection of late 12th-and-13th Dynasty boat models in the Egyptian Museum.....	76
33 A second boat from Dahshur excavations.....	77
34 GC 4926 on display.....	79
35 Stern of GC 4926, from below.....	81
36 Sandwich plank over the central strake of GC 4926, interior.....	84
37 Mortises stacked four deep on S5-3.....	85
38 Outboard beveling on the central strake, at the bow.....	86
39 Hull lines for GC 4926.....	89
40 Construction plans for GC 4926.....	90

FIGURE	Page
41 Flattened planking plan of GC 4926 - not to scale.....	91
42 Inboard surface of S5-3 and its joint with S5-4.....	94
43 Detail of double lashing on the weather strakes.....	96
44 A rabbeted throughbeam with deck planking.....	97
45 Throughbeam 2 from GC 4926.....	98
46 Throughbeam 11 and quarter rudder stanchions on GC 4926, from starboard..	100
47 Exploded mortises from the underside of a deck plank - GC 4926.....	102
48 An ancient mortise with pegged modern tenon in GC 4926.....	104
49 Lashing pattern at the bow of GC 4926.....	106
50 Tool marks on throughbeam 3 and deck planks in section 4 (room D) of GC 4926.....	107
51 QR1 - Quarter rudder one, associated with GC 4926.....	109
52 Starboard quarter rudder stanchion socket, GC 4926.....	111
53 Views of a Horus-head carving.....	112
54 Quarter rudder with udjat eyes, lotus flowers, and papyrus leaves.....	114
55 Three-dimensional rendition of the de Morgan boat.....	117
56 Three-dimensional rendition of GC 4926, with data points.....	118
57 A sledge found with the Dahshur boats and close up of ancient dovetail joint.....	123
58 Port end of throughbeam 10 on the de Morgan boat.....	129

INTRODUCTION

Throughout history ships and boats have been one of the central methods of spreading culture, generally via trade and war. Until the Industrial Revolution of the 18th century the primary means of trade and war was by such vessels. Watercraft were, and in many cases still are, the culmination of the most advanced technologies a society possesses, as well as clear indicators of power, strength, and wealth. The degree of bureaucracy ultimately required in the times of Christopher Columbus, Ferdinand Magellan and Sir Francis Drake to build even a single large ship for trade or exploration was second only to the money required to procure the materials and manpower. In ancient Egypt the ship was so essential to daily life, as well as to the growth and development of civilization, that the pharaohs were routinely buried with representations, models, and occasionally full-sized vessels, constructed of only the rarest timbers from neighboring lands.

The role that seafaring played in the discovery, conquest, and expansion of the world cannot be underestimated. Whether it was the trade and exploration on the Nile River in ancient Egypt that encouraged the rapid development of technology, the Greek triremes that dominated the Mediterranean for centuries, the exploits of Spain across the Atlantic to "discover" the New World, or the voyages of Portugal that established trade routes to the Indian and Pacific Oceans there is one common thread: the ship.

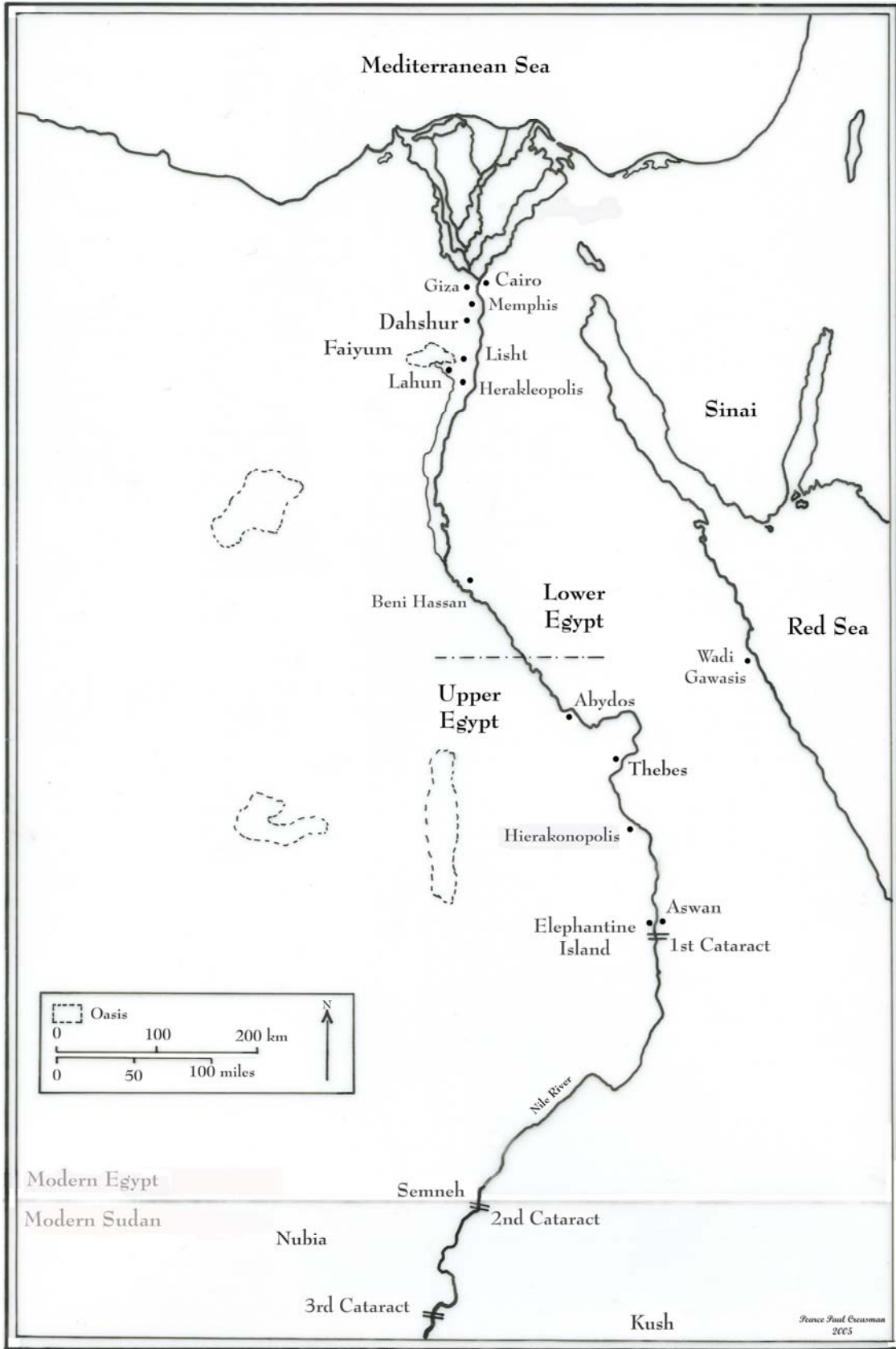

Figure 1. Map of ancient Egypt with key sites and regions.

In beginning a discussion on the history of ships, most scholars start in ancient Egypt¹ (Figure 1). The Arab Republic of Egypt, simply Egypt to most, today has the world's most densely concentrated population² for one primary reason: water. A review of the etymology of the name "Egypt" reveals a long standing dependence on and reverence for the waters of the Nile. During the Old Kingdom (2686-2125 B.C.) Egypt was called *Kmt* or Kemit from the hieroglyphs meaning "black land," after the color of the rich soils in the Nile Delta.³ Even the modern name "Egypt" originated from a secondary name for the word "Nile;" the Greek *Αιγυπτος*, or *Aigyptos*, finally corrupted to *Egypt*. The trend of dependence on and reverence towards the river was similar in ancient Egypt, with the population gathered around the available and largely predictable water source: the Nile.

Given its close daily association with the Nile, it is no surprise that one of the world's first great civilizations gradually developed an understanding of how to harness the gifts the river had to offer. The current flowing north into Lower Egypt and winds blowing south into Upper Egypt proved to be the perfect natural highway for efficient and reliable transportation.

Thousands of years older than the epics of Classical Greece or the founding of Rome, pottery from the Predynastic Naqada I (Amratian) period (c. 4000-3500 B.C.)⁴—and more frequently tomb paintings and pottery from the Naqada II (Gerzian) period (c. 3500-3100 B.C.)—provide evidence for river craft (Figure 2). The craft were already

¹ Bass 1972, 12-36; see also Steffy 1994, 23-37; Landström 1961, 12-24; Throckmorton 1987, 8; for popular version, see László and Woodman 1999, 13-20.

² Ninety-five percent of the country's 60 million people live on only five percent of the country's total land mass, clustered around the Nile and a few scattered oases (Lonely Planet 2004, 24).

³ Faulkner 1981, 286; see also Allen 2000, 476.

⁴ This thesis follows the basic chronology as found in Appendix A.

developed enough by late in the Naqada II period to wield the earliest sails in the world.⁵ At the same time near the end of the Predynastic Period (c. 5300-3000 B.C.) the first recognizable Egyptian cult of the death appeared, and with it a concentration on preparations for the afterlife.



Figure 2. Predynastic watercraft on a Naqada II period vessel in the Aswan Museum (P. Creasman).

The landscape on both banks of the Nile during the Old Kingdom was marked by massive monuments, including the largest man-made Pyramids of Giza, intended to preserve the memory, body, and goods of the pharaoh in whose name they were built. But preservation of a pharaoh's physical self was insufficient; his soul had to be prepared as well.⁶ In order to ensure the repetition of his life after death, a pharaoh would require all the same amenities as he had had during his life. This need was

⁵ Landström 1961, 12-16; see also Shaw 2000, 53-5; Bass 1972, 13; Tomb 100 at Hierakonpolis; Cairo GC 58677 and numerous artifacts in halls 53 and 54 of the Egyptian Museum for sail iconography.

⁶ The culmination of the rituals performed in preparation for the afterlife, which certainly began before or during the Old Kingdom, can be found in the New Kingdom *Book of the Dead* (Budge 1990).

reflected during the Old Kingdom by the interring of actual goods and necessities with the pharaoh such as water, food, clothes, luxury items, family, weapons, and certainly methods of transportation such as boats.⁷

For a combination of economic,⁸ political,⁹ and practical¹⁰ reasons a distinct trend of miniaturization and representation of the burial goods followed during the Middle and New Kingdoms. By substituting goods with miniature versions made of metal, clay, or wood, and by painting scenes on walls, the size of the tomb required for a pharaoh's resting place drastically decreased, as did the resources required to provide for the afterlife. Archaeological finds similar in scale and grandeur to the Khufu (Cheops: 2589-2566 B.C.) barge¹¹ were being phased out towards the end of the Old Kingdom as the lack of boat pits constructed with burials after the 4th Dynasty suggests.¹²

Miniaturization would also have proved quite beneficial in later ancient times when tomb robbing was recognized by the royal advisors and priests of the New Kingdom (1550-1069 B.C.) as a serious problem¹³—the objects were less valuable and practically useless as miniatures. Also, it was easier to hide the miniatures than the full-size objects.

A good example of both miniaturization and its effectiveness in protecting funerary goods were the models of daily life found in the re-excavation of the tomb of an 11th-Dynasty nobleman named Meket-Rē. In 1920 the Metropolitan Museum expedition

⁷ Grajetzki 2003, 15-53.

⁸ The custom of placing model boats in tombs as Jones (1990, 1-2) states "was due primarily to the worsening economic and political disorders prevalent at the end of the Old Kingdom..."

⁹ Too lengthy to be discussed here, but the *Oxford History of Ancient Egypt* (Shaw 2000) discusses many of the factors, as does Reisner (1913, i-v).

¹⁰ Jones (1990, 2) notes that using boat models was less costly and time-consuming but still provided the deceased with the necessary goods in the afterlife.

¹¹ Nour et al. 1960; see also Lipke 1984.

¹² Haldane 1984, 2.

¹³ As demonstrated by frequent removal and reburial of pharaohs in the Valley of the Kings; see Bryan (2004, 222) for discussion of reburial practices.

at Thebes decided to conduct "an act of archaeological consciousness" and properly cleaned and organized the nobleman's tomb which had been "worked over" 20 years before.¹⁴ With few expectations for their work, the Met was rewarded with a hidden chamber in which they found a spectacular collection of models (including six types of boats,¹⁵ several houses, and gardening scenes) that constituted the "best find ever" to authenticate home life, farming, and the economy in the ancient world (Figure 3).¹⁶ H.E. Winlock put it best commenting on the Meket-Rē discovery:

The spirits of these little Servants worked eternally, turning out spirit food or sailing ships upon a spirit Nile, and [Meket-Rē's] soul could enter any one of the little portraits of himself at will to reap the harvest of their labors. In short we had found a picture of the life the great noble had hoped to live in eternity, which was nothing more or less than the life he led on earth...¹⁷



Figure 3. Models of daily life—fishing. From the tomb of Meket-Rē (P. Creasman).

¹⁴ Magoffin and Davis 1929, 59-60.

¹⁵ Winlock (1955, 45-69) divided Meket-Rē's boat models into five types, where the group of "yachts" included two funerary boats. Winlock noted the possibility of an additional division between the yachts and funerary craft, but it was not until Landström (1970, 80) that the distinction was confirmed. However, later authors such as Bass (1972, 18-9) and Jones (1995, 30) opted to remain with Winlock's original typology; personal communication Cemal Pulak, 9 October 2005.

¹⁶ Magoffin and Davis 1929, 60; see also Winlock 1955, IV.

¹⁷ Winlock 1955, 6-7.

The boats discovered just outside Middle Kingdom pharaoh Senwosret III's mud-brick pyramid at Dahshur in the summer of 1894 provided another step in the progression of miniaturization. Measuring approximately 10 meters in length each, they are significantly smaller than those of Khufu, which measure approximately 43.5 meters.¹⁸ If Senwosret III was not the most powerful pharaoh of the Middle Kingdom he was at least the most visible.¹⁹ As a powerful pharaoh when he died he would have been accompanied in the afterlife with the best and highest quality funerary goods. Assuming these vessels were intended to accompany him, then during the 12th Dynasty the best boats available or deemed necessary for the pharaoh's afterlife were those of 10 meters (Figure 4).



Figure 4. Dahshur boat GC 4925 on display (J. Levin).

¹⁸ Personal measurements, taken with the kind permission of the Supreme Council on Antiquities.

¹⁹ Callandar 2000, 166.

Interestingly, Meket-Rē's burial predates Senwosret III's by nearly two centuries, but since Meket-Rē was only a nobleman it is not expected that he would be buried with as luxurious a funerary assemblage as those of a powerful pharaoh. Models of objects and events in daily life were not new to the Middle Kingdom by any means, but this period saw an explosion in the frequency of their use.²⁰ The drastic increase in the quantity of representations and small models of daily life, of ships and boats in particular, continued through the New Kingdom.²¹

The world's oldest collection of contemporary boats currently available for study was discovered in 1894 by Jean-Jacques de Morgan while excavating the 12th Dynasty pyramid complex of Senwosret III.²² Known as "Khakaure" to his people, Senwosret III reigned for an uncertain length of time, up to 39 years (c. 1870-1831 B.C.).²³ His reign included some of the most prosperous years of the entire Middle Kingdom. In addition to the reunification of Upper and Lower Egypt, the Middle Kingdom under his reign was known for social and cultural growth. It should come as no surprise, therefore, that upon his death he was sent to the afterlife in grand affair.²⁴

Over the millennia, the Pharaoh's pyramid complex at Dahshur served as a target for looting and grave robbing. However, de Morgan's excavations revealed unparalleled finds that included five or six small boats. While his excavation report *recorded* six

²⁰ See Reisner (1913, i-v) for a brief discussion of the history of boat models.

²¹ Jones (1990, 9-62) illustrates the 35 boat models that were found in the cache of King Tutankhamun, who ruled for only nine years; see also Reisner 1913.

²² de Morgan 1895, 1-2, 81-3, and pl. XXIX-XXXI; see also Appendix B for English translation of selected passages of de Morgan's excavation report *Fouilles a Dahchour*.

²³ In Griffith's (1898, 85) translation of the Turin Canon papyrus Senwosret III ruled for "30 + x" years. Portions of the papyrus are missing or illegible, thus obscuring the hieroglyphs enumerating the numbers of year over 30 which he served. Griffith also noted that the highest regnal year that could be determined by the remaining monuments was 26. While Callandar (2000, 165) agreed with Griffith's interpretation of the Turin Canon, she stated that the highest regnal year that can be accounted for by dated sources was 19. Ward (2000, 83) accepts only a length of 19 years; see also Appendix C for a translation of the 12th Dynasty section of the Turin Canon, with original hieroglyphs.

²⁴ Creasman 2005, 15; see also de Morgan 1895, 1-5.

boats, in two caches of three each,²⁵ he *mapped* only five of them in his publication (Figure 5).²⁶ Subsequent reports by de Morgan himself place the exact number at five.²⁷ Today, the locations of only four of the "Dahshur boats" are known: one each in the Carnegie Museum of Natural History in Pittsburgh and in the Field Museum of Natural History in Chicago, in the United States, while the remaining two are on display in the Egyptian Museum, Cairo, known only by their General Catalogue or "GC" numbers of 4925 and 4926. The whereabouts of the fifth boat is unknown and largely assumed to have been exported to a museum in Europe²⁸ or to be still in the sands at Dahshur.²⁹ Yet, evidence of charring on one of the Cairo boats suggests another possibility, that some time after de Morgan's excavation the fifth hull may have been lost to fire.³⁰

After their excavation the boats remained relatively inconspicuous until Cheryl (Haldane) Ward, made an in-depth study of the two hulls in the United States. As evidenced by Ward, the Dahshur boats were largely unpublished,³¹ but this neglect has been partially overcome with Ward's publications over the last 20 years that have focused on the boats in the United States; the two in Cairo, however, still remain obscure.

²⁵ de Morgan 1895, 82.

²⁶ Ibid, VII, fig. 105

²⁷ de Morgan 1896, 600; 1897, 11.

²⁸ Peet 1902, 187-88.

²⁹ Hawass, Z. 2004, 24 November. *Sidebar: The Boats of Dahshur*. <http://www.guardians.net/hawass/mortuary1.htm> (24 November 2004).

³⁰ It was not uncommon for workers during the 19th and early 20th centuries to burn timber found at sites, however, under de Morgan's watch this would have been quite unlikely. Unfortunately, he remarked throughout his excavation report about the poor quality of work by his workmen and that he was often absent. One section stands out [translation from de Morgan (1895, 84-5)], "It is extremely difficult to obtain... methodical and regular work [from the local workmen]... it is nearly impossible to make them follow one specific direction...The workers were doing the piecemeal, carefully avoiding the hardest banks and researching the most tender where doing the work is the most lucrative [easiest]."

³¹ Haldane 1984, 1-7, 65, 83; Most references and all published photographs of the Cairo Dahshur boats that I am aware of neglect to label the vessel: see Partridge 1996, fig. 35.

Pyramid Complex of Senwosret III
at Dahshur

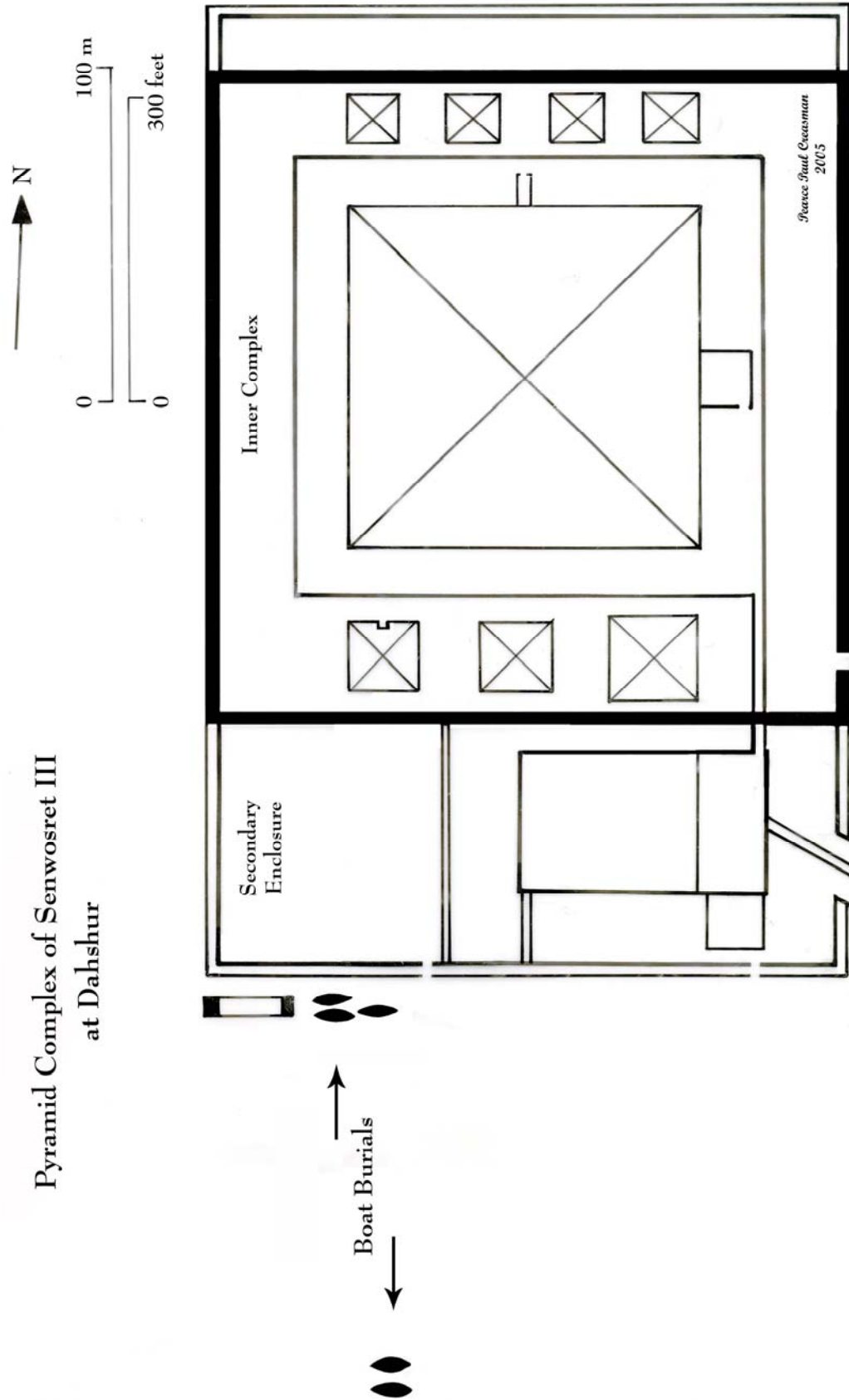

Figure 5. Site map of the pyramid complex of Senwosret III (after de Morgan 1895, Fig. 105).

While conducting bibliographic research in the fall of 2003 to draft a set of lines for one of the boats in Cairo, I noticed significant discrepancies in several critical measurements, a problem exacerbated by the limited number of articles and publications on the subject. Drafting the first set of ships lines with only the limited written records regarding the Cairo Dahshur boats made me realize that these craft needed additional attention. Moreover, certain questions posed in Ward's work suggested the Cairo boats would have benefited from a more in-depth study.³²

All four boats exhibit what is considered an atypical construction method for ancient Egyptian watercraft: dovetail fastenings between the planks. While the use of dovetails was frequent in ancient Egyptian furniture construction and not uncommonly employed in other wood structures, such as coffins, they are notably rare in the archaeological and iconographic records of boats.³³ Typically, a system of rope lashings combined with mortise-and-tenon joinery was used to keep the hull planks from separating under normal use and stresses.³⁴ Both Cairo Dahshur boats exhibit frequent mortise-and-tenon joinery³⁵ and dovetails but the only evidence of lashing is confined to the bow, stern, and weather strake (upper-most strake) of each boat (Figures 6, 7, 8, and 9).

³² Ward (2000, 84) spent only "an afternoon" in 1986 recording both of the Cairo hulls.

³³ While working at the Egyptian Museum in May 2005 I was privileged to view two unlabeled boat models from the King Tutankhamun collection that were being restored. I noticed that the hulls consisted of two pieces each, both joined by a single dovetail in the center. The primer and paint had chipped away to clearly expose the use of such fastening. Other than these two examples, however, I am aware of no other instances that include dovetail fastenings in context with ancient Egyptian boat construction. Here I used the word "construction" lightly, as these models were generally crafted by artisans, not shipbuilders.

³⁴ As defined by the few extant boatbuilding scenes in tombs, such as Khamunhotep III at Beni Hassan and Tí at Saqqara, and the available artifacts; see also Tooley (1995) and Jones (1998) for iconography and brief discussion of ropes on Egyptian vessels.

³⁵ As frequent as the use of mortise and tenons were in boat construction, I am only aware of one representation in the iconographic record, that from the 5th-Dynasty tomb of Tí (Hocker 1998, figs. 10.16 and 10.17).



Figure 6. Mortise-and-tenons joining port strakes 4 and 5 on GC 4925 (P. Creasman).

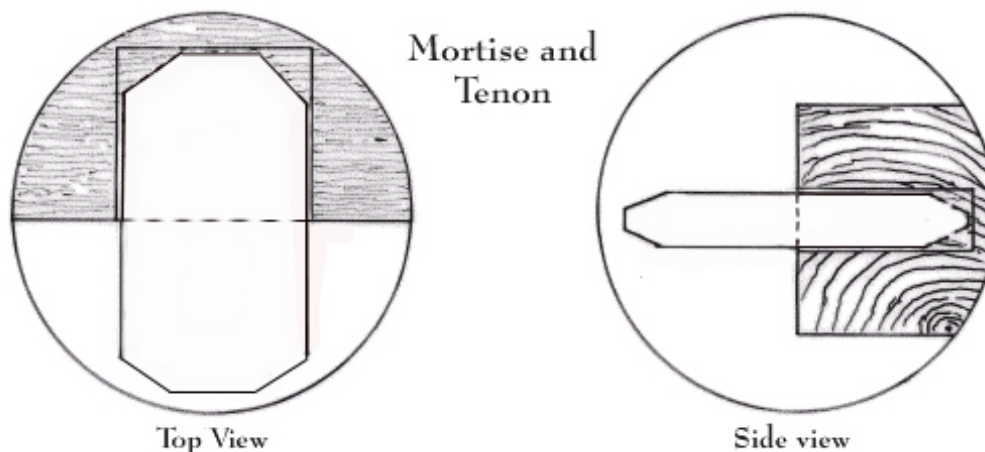

Figure 7. Mortise-and-tenon joinery (P. Creasman).

Are the dovetails an original part of the Dahshur boats' construction, or are they the result of modification, adaptation, or repair made by the caretakers at the turn of the century? Here de Morgan's excavation report is somewhat revealing, stating:

The construction of these boats is remarkable: we do not see their interior decorated with *framing* as is customary to do today with modern boats, but the various planks are fixed securely—one on the other—in the middle with tenons returning into some mortises ...[when the first two boats] were recovered... [they] were still holding perfectly rigid. In order to transport them without risk, I constructed a wood casing around each one.³⁶ (*emphasis added*)

The word *framing* as written in the original French, *d'armatures*, has two common meanings. The second meaning is "wiring" and discussions with students of late 19th-century French literature suggest that at the time this would have been equally

³⁶ Translated from de Morgan 1895, 82; see Appendix B.

if not more likely to be the proper interpretation.³⁷ While de Morgan specifically notes the existence of mortise-and-tenon joinery, which would have been less conspicuous than either lashings or dovetail joints, he makes no effort to describe either. However, in January of 1895 A.L. Frothingham Jr. noted that "the planks of the hull[s] are fixed together with dove-tailed dowels and [mortise-and-tenons]."³⁸ Therefore, the question remains: were the dovetails original to the ship or simply post-excavation replacements? Should they be post-excavation replacements it would be difficult to explain why all four hulls exhibit identical dovetail features when at least one of them was excavated from the sands years after de Morgan's excavation was completed.

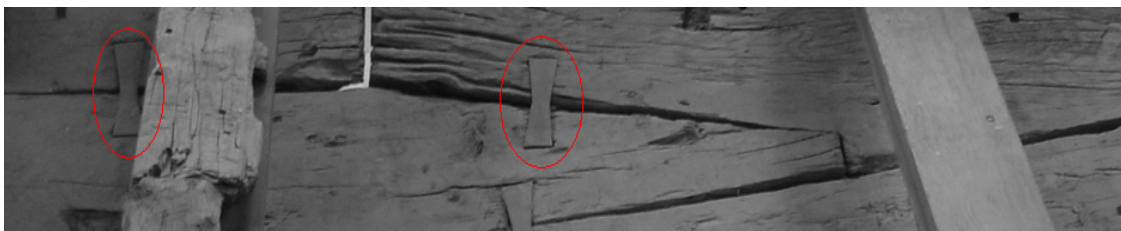

Figure 8. Dovetails joining port strakes 1 and 2 on GC 4925 (P. Creasman).

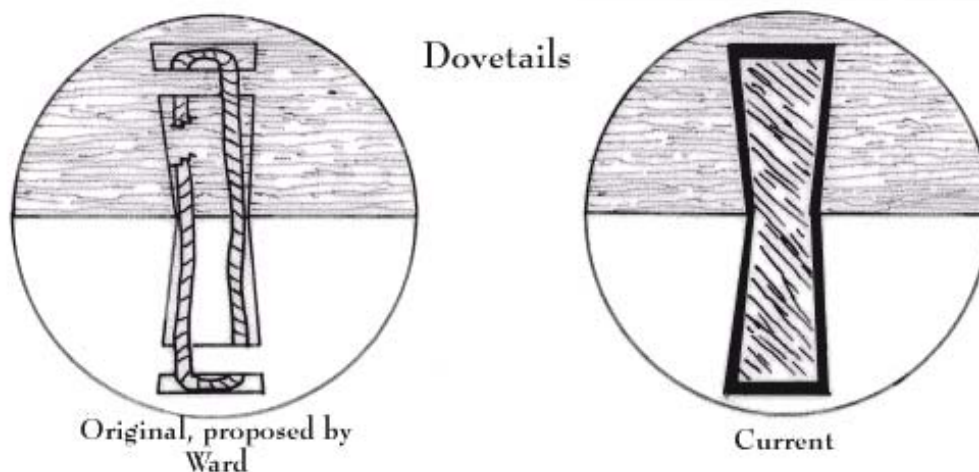

Figure 9. Dovetail joinery (P. Creasman).

³⁷ Personal communication Abbey Barden, 5 February 2005.

³⁸ 1895, 72.

In hopes of answering this and other questions, I wrote to the General Director of the Egyptian Museum in December 2003 requesting permission to record and study the boats in their care. In less than three weeks I received a favorable response, thus permitting the first of two research sessions in Cairo. By June of 2005 my small team and I had spent over six weeks working on the floor of the museum recording the two hulls.³⁹ Several challenges were apparent in our work that merit mention. The primary hurdle was the condition of the boats. Neither was in good enough condition for the staff of the Egyptian Museum to permit complete disassembly, and physical interaction was limited only to "necessary" handling of the timbers. Also, the museum work schedule in Cairo was much shorter than anticipated; 9:00 a.m. to 3:00 p.m., thus requiring more days to make the necessary recordings than originally planned.

It is the goal of this thesis to present an organized description and analysis of the two Cairo Dahshur boats. As will be seen in the chapters below, generalized conclusions cannot be drawn from a study involving only some of these boats, as there are drastic conceptual differences demonstrated by the Cairo hulls that could not be ascertained by a cursory preliminary examination, a survey of the extant academic record, or by examining only the two vessels in the United States. Prior to describing and analyzing the Cairo boats it is useful to make a brief study of the people and period when these craft were built and used. By developing an understanding of the contemporary environment from which the boats came, one can gain a better understanding of the technical merits of the crafts themselves.

³⁹ The 2004 team consisted of Alex Hazlett and Brian Hill, graduate students from Texas A&M, and Shima Sadek, an exceptional restorer from the museum. The 2005 team consisted of Joshua Daniel, Tom Larson, and Joshua Levin, also graduate students from Texas A&M. Please see Creasman 2005 regarding the details of these field sessions.

THE MIDDLE KINGDOM, THE 12TH DYNASTY,
AND SENWOSRET III

Establishing exact dates and a chronology of ancient Egypt has been one of the most difficult tasks assumed by Egyptologists since Manetho wrote the first modern history of the Pharonic Era in the third century B.C.; dividing the Pharonic Era into Kingdoms and Dynasties was his most lasting achievement. Since Manetho, several notable historians and Egyptologists have significantly advanced the sequence of rulers with the help of textual documentation such as the "List of Kings" at Abydos and the "Turin Canon" from Lahun. While the sequence of the pharaohs in most Dynasties has come to be fairly well understood (e.g., Amenemhat II immediately preceded Senwosret II, who was followed by Senwosret III), the dates associated with their reigns differ from publication to publication. The concept of co-regencies has added an interesting series of debates that aim to rectify apparent overlaps in rule. This thesis will largely follow the chronology applied in the *Oxford History of Ancient Egypt (OHAE)*, although some dates are adapted to reflect recent evidence.⁴⁰

The Middle Kingdom (c. 2060-1650 B.C.) consisted of three dynasties, the 11th (2060-1985), 12th (1985-1773), and 13th (1773-1650) that generally corresponded with the rise, renaissance, and fall of the kingdom, respectively. As a whole, the Middle Kingdom is known for a core of political unity⁴¹ located closer to the migrating border of Upper and Lower Egypt than during previous dynasties, in the Faiyum and Lisht regions

⁴⁰ *OHAE* (Shaw, 2000); see Appendix A.

⁴¹ Callandar 2000, 148; Generally, the designation of a new kingdom incorporates a physical or political divergence from the previous series of rulers. The beginning of the Middle Kingdom is marked by drastic changes in both.

(Figure 10). While many of the specifics of the period remain fragmentary and highly debated, the general historical outline is largely agreed upon.⁴²

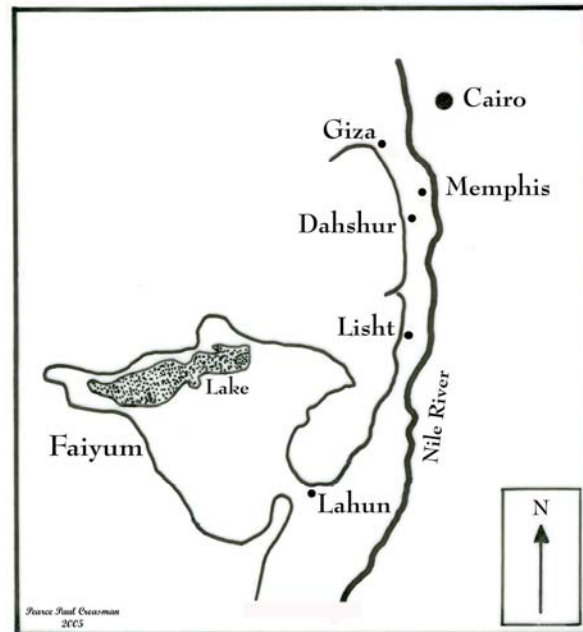

Figure 10. Map of the Faiyum region with key sites (after Grajetzki 2003, fig.2).

Mentuhotep II (2055-2004) established the Middle Kingdom when he succeeded Intef III (2063-2055) of the First Intermediate period on the throne at Thebes. Mentuhotep's consolidation of power, strong leadership, and re-organization of the ruling class marked the changed from the weak and disorganized rule of Intef. Mentuhotep, moreover, guided the state through at least 14 years of notably violent civil wars against the noble families of a traditional seat of power in Lower Egypt known as Herakleopolis,⁴³ a feat that none of the pharaohs of the First Intermediate Period could accomplish. By ruling from Thebes in Upper Egypt the pharaoh was in a better position to hold control over the troublesome regions there that had largely contributed to the fall

⁴² Parkinson 2002, 5.

⁴³ Callandar 2000, 151.

of the Old Kingdom. The pharaoh created or reinstated a series of political posts that began to centralize the power at his capital.⁴⁴ Such centralization of power became a constant trend throughout the Middle Kingdom.

The next two pharaohs to succeed Mentuhotep II, Mentuhotep III (2004-1992) and Mentuhotep IV (1992-1985), were particularly vigorous in employing builders to construct temples and, perhaps for the first time, projects of general utility as well. During the 11th Dynasty the earliest voyages to Lebanon and Punt were recorded, amongst other foreign centers that would become prominent in later ancient Egypt. The circumstances of the transition from the 11th to the 12th Dynasty, that is from Mentuhotep IV to his vizier Amenemhat I (1985-1956), are somewhat suspicious, although it is unlikely that overt foul-play was involved as Amenemhat was at the fringes of the kingdom, engulfed in battle after battle expanding the state. By most reports Amenemhat was a faithful servant of the pharaoh who took advantage of another person's attempted coup. Gae Callandar, a scholar of Middle Kingdom Egypt, suggests that the lack of a viable male heir or general weakness of the pharaoh permitted one of the high-ranking officials, Amenemhat I, to take power.⁴⁵

With the dawn of the 12th Dynasty came the move of the royal court and capital to Lisht in the Faiyum region. Amenemhat I continued to actively consolidate his country's borders as he had done so as vizier,⁴⁶ and usurped the power of the

⁴⁴ For example, Mentuhotep II installed "governors" of Upper and Lower Egypt that he appointed and regulated directly.

⁴⁵ 2000, 156.

⁴⁶ Parkinson 2002, 5.

nomarchs.⁴⁷ After approximately 30 years of rule Amenemhat I was assassinated and his son and co-regent,⁴⁸ Senwosret I (1956-1911), took power.⁴⁹

Senwosret I continued the economic and social growth of the dynasty by expanding southwards, sending expeditions to Asia, and for the first time conducting frequent trade with Syria.⁵⁰ The "royal mortuary cult"⁵¹ or a supreme reverence for the pharaoh also re-emerged under his rule, although by this time certain rituals previously reserved for the nobility had diffused into the populace. Most notably, Senwosret I's rule of approximately 34 years established a single unified material culture in ancient Egypt,⁵² intentionally reminiscent of the Old Kingdom. The importance of a unified culture cannot be underestimated. When the citizens of a state are allied in their general beliefs and way of life, they are more willing to being directed and governed. Periods of weakness during ancient Egypt were marred by the effects of independent cultural centers grasping for power, which usually resulted in the transition of pharaohs and dynasties.

The similarly long rule of Senwosret I's son, Amenemhat II (1911-1877), appeared to be consistent with that of his father—though less remarkable. The rule of Amenemhat II's son, Senwosret II (1877-1870), was comparatively short, probably due

⁴⁷ "Nomes" were local governates along the Nile. "Nomarchs" were their traditional or familial rulers.

⁴⁸ The concept of co-regency has been a subject of frequent debate in Egyptology for decades and both supporters and opponents present formidable cases. It is not necessary to either accept or deny co-regency for the purpose of this thesis.

⁴⁹ The manuscript titled *The Teaching of Amenemhat I* (Lopez 1963, 29-33) is particularly useful for understanding this succession.

⁵⁰ Callandar 2000, 161; see also Parkinson 2002, 5.

⁵¹ Bard 2004, 74.

⁵² Parkinson 2002, 5; see also Franke 1994, 8-29; Obsomer 1995, 103-40; Trigger (1993, 109-12) discusses many of the benefits in having a united material culture, although he does not use this term.

to his advanced age from the two somewhat lengthy preceding reigns.⁵³ Yet, these were good years. Under Senwosret II there was a distinct lack of military action—or perhaps only of records—permitting more time to be spent focused on other affairs of the state including a prolific Near Eastern trade and the institution of an irrigation system in the Faiyum region.⁵⁴ After Senwosret II, what has been called the "high Middle Kingdom" (c. 1870-1777) commenced with the reign of Senwosret III (Figure 11).



Figure 11. Statue head of Senwosret III at the Luxor Museum (P. Creasman).

⁵³ The length of Senwosret II's reign is actively debated. The *Lahun Papyri* gives a length of 19 years, confirmed by Griffith (1898, 85). However, the longest period of reign that can be accounted for by monuments and inscriptions is nine years. These ambiguous lengths of rule have encouraged the concept of co-regencies between a pharaoh and his successor.

⁵⁴ Callandar 2000, 164; see also Erman 1971, 41.

As the most "visible" and perhaps most controversial pharaoh of the Middle Kingdom, many of Senwosret III's exploits inspired the development of the Classical Greek heroicized character "Sesostris."⁵⁵ The adventures of this semi-mythical person are based on the deeds of Senwosret III, but the tales also include events that happened centuries after the pharaoh's death. Regardless of later developments, Senwosret III's rule was responsible for expanding the empire in all directions, a massive centralization of government, and a growth in trade and technology among other major social, political, and cultural changes.

Senwosret III, or Khakaure,⁵⁶ reigned for 19 to 39 years with the exact dates difficult to establish.⁵⁷ This was, without doubt, a very prosperous time for Egypt. Some of the earliest records of his reign are from his eighth year when the pharaoh had his master builder, Ronpetenenkh, clear a canal at the First Cataract 150 cubits long by 20 cubits wide by 15 cubits deep in order to sail his armies up the river into Nubia.⁵⁸ Khakaure personally led his armies to many great military victories and most importantly secured the Nubian frontier up to the Second Cataract. There he established

⁵⁵ Breasted 1906, 189; see also Callandar 2000, 166.

⁵⁶ Khakaure is Senwosret III's primary ceremonial name; see Appendix D for further discussion of the Royal Titulary.

⁵⁷ See n. 21; see also Appendix C; An account of Senwosret III's appointment of Amenemhat III as co-regent was recorded at a temple at Arsinor in the Faiyum (Breasted 1906, 189). As Amenemhat III ruled for upwards of 50 prosperous years a lengthy co-regency could explain the varying dates for the reign of Senwosret III. Additionally, there is record of Senwosret III holding his "*sed*-festival" or royal jubilee. This was usually reserved for the 30th year of reign, or later. For example, Mentuhotep II held his *sed*-festival in his 38th year of reign (Callandar 2000, 152) and Senwosret I held his in his 31st year of reign (ibid, 161). Conversely, a statuette at the Metropolitan Museum of Art has an inscription of the occurrence of Queen Sobekneferu's *sed*-festival when it is confirmed that she only ruled for four years at the end of the 12th Dynasty.

⁵⁸ Weigall 1927, 86; see also Breasted 1906, 183; the canal measured approximately 260 x 34 x 26 feet or 85 x 11 x 8 meters; There is no archaeological evidence that Senwosret III's armies used sails during their campaigns, but sail had been known in Egypt for over 1000 years by then and would have been the most efficient method of propulsion.

two major forts, Semneh and Kummeh, one on each side of the river.⁵⁹ Later, the pharaoh re-extended the limits of the empire up to the Third Cataract at Kerma, which had been reached some 600 years prior but was not able to be controlled. From the trading post he had set up at Aswan⁶⁰ and from his fort at Elephantine Island, Senwosret III held the restless Kush people at bay and eventually became a patron deity in Nubia, the land he had ruthlessly conquered.⁶¹ While most of Senwosret's military activity was concentrated in the south, other monuments recorded his personal ventures east to the Red Sea and Somaliland, north to re-open the copper mines of Sinai, and west into the Libyan Desert.⁶²

At home Senwosret was continuing the practices initiated by his predecessors to centralize the government around his court. Although attempts were made earlier during the Middle Kingdom to reduce the power of the nomarchs, it was this pharaoh that was responsible for instituting the practices that usurped their remaining power. Senwosret required the male children of nomarchs to be educated at Lisht and then serve the state somewhere detached from their homeland. Nearly all of the nomarchs were personally appointed by the pharaoh⁶³ and many of their traditional titles disappeared from the archaeological record.⁶⁴ Practices such as those mentioned above crippled the succession of the powerful familial nomarchs.

⁵⁹ Breasted 1906, 185; see also Weigall 1927.

⁶⁰ The name "Aswan" literally means "to trade" and can probably be credited, in part, to Senwosret III's establishments there and specific legislation he enacted regarding trade with the Nubians and Kush.

⁶¹ Weigall 1927, 92.

⁶² Ibid, 99-100; see also Petrie's *Tanis* v.I, Gardiner and Peet's *Sinai*, and Couyat and Montet's *Hammamât* for further evidence.

⁶³ Callandar 2000, 175; this practice was adopted "during the 12th Dynasty" and was certainly employed effectively by Senwosret III, although it is uncertain if he was the first to impose this method.

⁶⁴ Personal communication Tracy Musacchio, 20th May 2005; see also the numerous dated stelae of the Middle Kingdom, particularly of the Egyptian Museum; Callandar 2000, 148-83.

Because of the influx in the population of the capital, more positions became necessary to teach the nomarchs' children and to keep them employed afterward. It is not surprising that during Senwosret's reign numerous Old Kingdom titles were brought back and even more new titles were created. In order to centralize and keep the powerbase of the state within his court, Senwosret inadvertently created a bureaucracy like never seen before,⁶⁵ including the bureaus of Upper Egypt, Lower Egypt, treasury, labor, military, vizier, and "bureau of the people's giving."⁶⁶ Each bureau not only required a head but numerous sub-positions, thus occupying the otherwise potentially threatening nobles. All of these positions came with their inherent restrictions under the watchful eyes of pharaoh and his trusted elite, but also came with benefits. The positions expanded the middle class as quickly as they were instituted. People other than the lavish elite could then afford to prepare for the afterlife in a manner similar to that of their pharaoh. The material record from Senwosret's reign confirms the participation of the middle class by the frequency of less wealthy burials. Many funerary stelae describe the nature of the deceased's position within society and eliminate the objectivity inherent in identifying "less wealthy" burials.

Distinct trends within the culture and most visibly within architecture and funerary practices emerged based on the changing dynamics of the society.⁶⁷ Each scholar that has researched Senwosret III has encountered statues and other stone likenesses of him that, for the first time in ancient Egypt, depicted a pharaoh with non-idealized facial features. Many of the representations of Senwosret reveal the portrait of a worldly man, not a god-incarnate. Also under Senwosret's reforms the middle class

⁶⁵ Callandar 2000, 175.

⁶⁶ Ibid, 175.

⁶⁷ See Parkinson 2002, 6; Callandar 2000, 180.

began to actively participate in the "cult of Osiris" and the belief of the existence of a "ba" or spiritual force that had formerly been strictly reserved for the pharaohs.⁶⁸

Although not certain, this also appears to be the time when the mummiform coffin was introduced; whether this was directly associated with the status of the state, however, is not known.⁶⁹

Cultural changes during the high Middle Kingdom could be due in part to increased contact with other societies. Just as Senwosret's expeditions took him to the physical boundaries of his kingdom, the same expeditions also took soldiers, viziers, nobleman, and merchants alike. An increase in cross-cultural contact was a side effect of Senwosret's reign. While cultural information was both intentionally and inadvertently traded, technological information would have been as well. Interaction with other societies is reflected in distinct architectural trends from the period. Although the mud-brick pyramids of the Middle Kingdom are viewed by some Egyptologists as inferior attempts to copy the works of the Old Kingdom, Callandar notes that "[the Middle Kingdom] engineers and architects reached great heights of mastery [and] exceeded the considerable skills of their Old Kingdom counterparts."⁷⁰

Senwosret III had only one son, Amenemhat III. Building on the vast successes of his father, Amenemhat III reigned for approximately 46 years, bringing peace and cultural expansion to his land. No records of military activity during Amenemhat's reign are known and it is safe to assume that the active military under his father was largely responsible for preparing the Kingdom for a lengthy period of peace. During this time

⁶⁸ Callandar 2000, 180.

⁶⁹ Callandar 2000, 148-83; It is unlikely that one individual made a singularly causative contribution to this trend. However, it is noteworthy that this trend emerges during a time when culture was being redefined.

⁷⁰ Callandar 2000, 181; See also the section in this thesis titled "Analysis."

the pharaoh occupied his people with numerous additions to temples and fortresses to shore up their borders. He also had turquoise and copper mines of the Sinai worked heavily.⁷¹ Towards the end of Amenemhat's reign there were several years of low floods on the Nile,⁷² which stressed the state's economy. The end of Amenemhat III's reign marked the beginning of the decline of the 12th Dynasty and the Middle Kingdom.

Amenemhat IV, who followed Amenemhat III, may or may not have been his son.⁷³ Regardless, the new pharaoh ruled for only nine years before his death, in which no major events affecting the Kingdom or Dynasty are known to have taken place. He was succeeded by Queen Sobekneferu who may have been his sister and was probably also his wife. Her four-year-rule seemed to be effective and legitimate, as she is listed in the *Turin Canon*, but nonetheless she was the last ruler of the 12th Dynasty.

Aldolf Erman writes that the kings of the 12th Dynasty raised the Kingdom to a level of civilization never seen before and their prosperity was so great that "it is easy to understand how the later Egyptians looked back to it as a national classical epoch."⁷⁴ The opportunity to study and compare complex artifacts from the national epoch to which Erman referred is presented in the Cairo Dahshur boats.

⁷¹ Callandar 2000, 168.

⁷² As recorded at the fortresses at the Second Cataract (Breasted 1906, 184-85).

⁷³ Parkinson 2002, 6; see also Callandar 2000, 170.

⁷⁴ 1971, 41; Thutmose III, a pharaoh during the New Kingdom c. 1450 B.C., dedicated temples to Senwosret III south of Aswan in reverence to his achievements that had become legendary there.

EGYPTIAN MUSEUM, CAIRO GC 4925 -

THE DE MORGAN BOAT

Much debate has centered on an exact understanding of the Dahshur boats' excavation sequence. De Morgan records the excavation of three vessels during May and June of 1894,⁷⁵ of which, to date, only the one at Chicago's Field Museum has been confirmed to be from the original set.⁷⁶ A solid case has been made that the boat at the Carnegie Museum in Pittsburgh, purchased by Andrew Carnegie himself, came from the excavation of the second cache, likely during 1902.⁷⁷ Although there is no question of their origin, very little research has been published regarding the history and excavation of the two boats in the Egyptian Museum.

In his excavation report de Morgan specifically states that two of the boats from his 1894 excavation, one "red" and one "white," went on display at the Gizeh Museum, the forerunner of the Cairo Museum.⁷⁸ This would have been expected as during the mid-1890s de Morgan was the Director-General of Antiquities in Egypt. Such a title then included the responsibility of monitoring, improving, and maintaining the national museum. Subsequently, de Morgan recorded one of the boats from his excavations in his report, but which boat it was has been unclear until now. Recent study of the boats in Cairo, de Morgan's excavation report and its associated plates, have revealed that the

⁷⁵ 1895, 82.

⁷⁶ Ward 1985, 174-175; see also Holland 1903, 77-8.

⁷⁷ Carnegie was in Egypt visiting the notable sites, which certainly included Dahshur, in the late summer and fall of 1894 (Winslow 1894, 307). This trip was only a few months after de Morgan's discovery of the boats and, more notably, "the most dazzling discovery ever made in the valley of the Nile" (Winslow 1985, 238) regarding the cache of gold and jewelry associated with the princesses and queens at Dahshur. It is likely that at this time Carnegie became aware of the boats and subsequently arranged for the purchase of one; see also Patch and Haldane (1990, 1-11); see also contemporary reports by Peet (1902, 187-8).

⁷⁸ 1894, 83; The Egyptian Museum, Cairo, or "Cairo Museum" as it is commonly called, opened in 1902. Previously, a smaller museum was housed across the Nile at an annex of the Gizeh (Giza) palace of Ismail Pasha, then ruler of Egypt.

boat he chose to represent in his report is almost certainly the vessel currently labeled GC 4925 in the general catalogue of the Cairo Museum and the one he referred to as the "white" boat.⁷⁹

When referring to "the Cairo boats" it is easy to confuse the two as they are only known by their catalogue numbers 4925 and 4926. In an effort to eliminate this confusion, throughout the remainder of this thesis "GC 4925" will be referred to as the "de Morgan boat" for reasons discussed below.⁸⁰

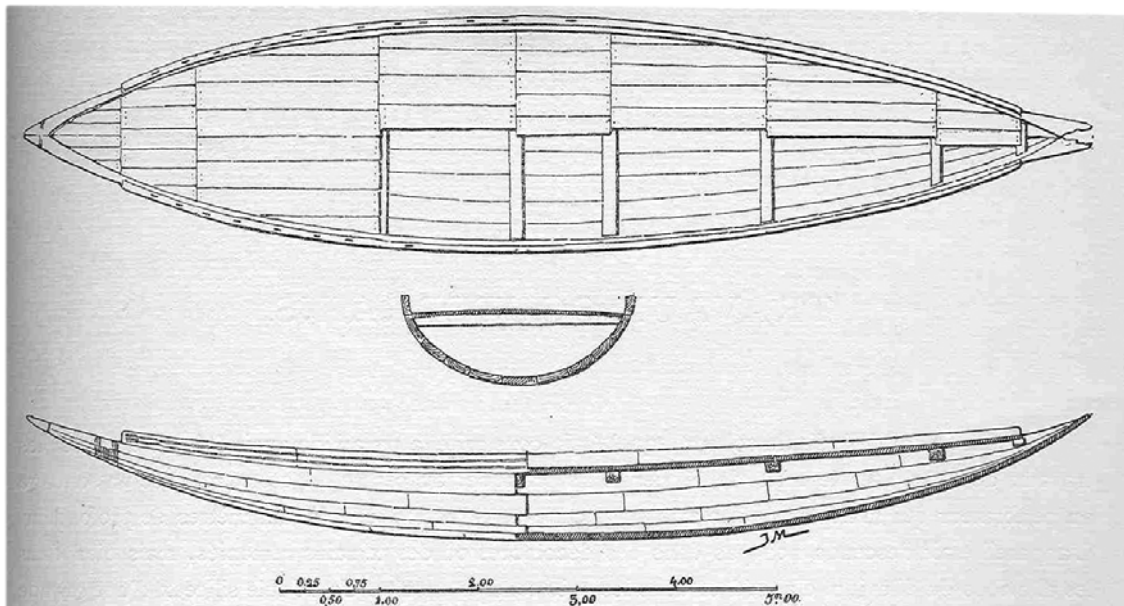

Figure 12. First drawings of the de Morgan boat (from de Morgan 1895, fig. 203).

Several key philosophical and constructional differences distinguish GC 4925, the de Morgan boat, from the other extant Dahshur boats. The most revealing differences can be found in an examination of the deck and throughbeams. The remaining original throughbeams (4, 7, 9, 10, and 11) are primarily rectangular in section, are not provided

⁷⁹ The boat de Morgan illustrated and photographed for his excavation report is either the boat known as "GC 4925" or it is the missing "fifth" boat. If the former, then it is most unlikely that the boat de Morgan chose to illustrate in his publication would have gone anywhere other than the Gizeh Museum.

⁸⁰ GC 4926 will continue to be referred to by its catalogue number. There is no need to rename both boats, nor is there any evidence to suggest a new name for GC 4926.

with ledges or rabbets for the deck planking, and the deck planks are secured to them by numerous treenails.⁸¹ Moreover, the de Morgan boat is the only boat in the group to use deck planks spanning more than one room (a "room" being the longitudinal space between one throughbeam and the next) and covering completely the top faces of the throughbeams. The concept of penetrating any structural element of the vessel is rarely seen on the other Dahshur boats at least not in this scale. Piercing the deck planks to affix them to the deck beams with treenails with such frequency requires more effort and a significantly different mindset of the boat builder.

Fortunately, for the purpose of identification, de Morgan illustrated these unique features in his excavation report (Figure 12). Since he recorded the one boat in the group that is unique in its construction, it is no wonder why recent scholarship has largely discounted or ignored his drawings. Although his work is useful, de Morgan made critical mistakes in leaving out several elements from his drawings, such as the three throughbeams that did not serve to support the butt joints of the deck planking. By applying de Morgan's deck plan, and matching up actual treenail holes on planks with those on the original throughbeams, several of the deck planks can be fitted to their original locations to confirm the positions of the throughbeams previously omitted in de Morgan's drawings. When the missing throughbeams are added to his plans at the widest rooms, the number of throughbeams totals 11, the same number as found today.

This is the longest of the four boat set and the only one to presently measure over 10 meters, a factor also reflected in de Morgan's drawings. Based on de Morgan's scale his boat drawings correspond to approximately 10.2 m—the same length given by G.A. Reisner to GC 4925 in his 1913 catalogue, and within two centimeters of my own

⁸¹ See the section below titled *Throughbeams and Deck Planking* for illustration and further information.

measurements.⁸² Dimensions for beam and hold depth calculated from de Morgan again match those of Reisner and myself. Therefore, the boat de Morgan recorded in his publications must be the same vessel later labeled by Reisner as "GC 4925" (Figure 13).



Figure 13. The de Morgan boat on display, from bow (J. Levin).

The de Morgan boat was uncovered on or around May 12th, 1894 as revealed by its photograph in the excavation report, and it was probably exhumed shortly thereafter (Figure 14).⁸³ De Morgan implies that after excavation the boat, along with GC 4926,

⁸² The 2-cm difference in my own measurement (10.22 m) and that of de Morgan's is negligible and is likely due to hull distortion or attrition over time, or simply to the use of different measuring tapes and/or measurement locations, not to mention aggrandization error from measuring small-scale drawings.

⁸³ Inspection of the image under magnification reveals the unique deck planking configuration recorded by de Morgan which is present only on GC 4925. It is also reasonable to assume that de Morgan illustrated the earliest boat excavated, permitting him ample time to prepare his report for publication.

was taken directly from Dahshur to the Gizeh Museum.⁸⁴ The earliest account of the presence of the boats at the Gizeh Museum comes from Frothingham's "Archæological News" in the January 1895 issue of *American Journal of Archaeology and of the History of the Fine Arts (AJAHFA)*. Frothingham's archaeological reports included most of the notable announcements, events, discoveries and donations that occurred in the archaeological world.⁸⁵ As both an educated and informed individual, few if any significant happenings in Egyptology escaped Frothingham and his pen. Consequently, the arrival of these new and interesting artifacts in Cairo was well within his scope of interest, and he wrote: "two large boats from Dahshur" were placed on display in the museum, measuring at most about 30 feet in length, 7 feet in beam, and 3 feet in depth.⁸⁶ Frothingham's record of the arrival of the Dahshur boats in Cairo plays a significant role in establishing an early timeline for the boats. Fortunately, Frothingham's contributions to *AJAHFA* were regular, bracketing the time frame in which the boats could have arrived in and placed on display in Cairo to roughly three months, between December of 1894 and March of 1895, the publication dates of his previous and subsequent contributions to the periodical. However, there appears to be no record of the vessels until their move to the Cairo Museum around the time it opened. The history of the boats while at the Cairo Museum is also difficult to trace, but it seems that they were continuously on display with no recordable instances of exception since their installation there. The artifacts found by de Morgan at Dahshur have constituted one of the most favored displays at the museum by tourists and staff for the last century. Due to a sense

⁸⁴ 1894, 82-3.

⁸⁵ During Frothingham's time the archaeological community was quite small and interconnected, allowing one person to effectively keep tabs on nearly all events of consequence.

⁸⁶ 1895, 71-2.

of nostalgia it seems unlikely that these treasures have or will ever be removed from the exhibit floor.⁸⁷



Figure 14. Excavation photograph of the de Morgan boat (from de Morgan 1895, plate XXIX).

As displayed in the Cairo Museum, the de Morgan boat is 10.22 m long, 2.26 m wide, and 0.86 m deep (Figure 15).⁸⁸ It is constructed of thick cedar timbers,⁸⁹ of which the center strake is the thickest that tapers slightly with each adjacent strake outwards. The central strake, laid flush with the inboard and outboard surfaces of the hull, serves as

⁸⁷ De Morgan's finds at Dahshur, primarily the jewelry, was considered the first great exhibit to draw people to the new Egyptian Museum in Cairo, in late 1902. Of the other "great treasures" at the Cairo Museum, the tomb of Yuya and Thuya was not found for a decade after the Dahshur finds went on display, and an additional decade elapsed until the finds from the tomb of Tutankhamun were added to the Museum.

⁸⁸ This measurement is from the top of strake 5. From the top of strake 4 the depth is 0.64 m.

⁸⁹ No samples were taken to scientifically identify the wood used to construct the vessel. It is likely, however, that the vessel is constructed of cedar, as has been confirmed with the Chicago and Pittsburgh boats (Ward 2000, 84).

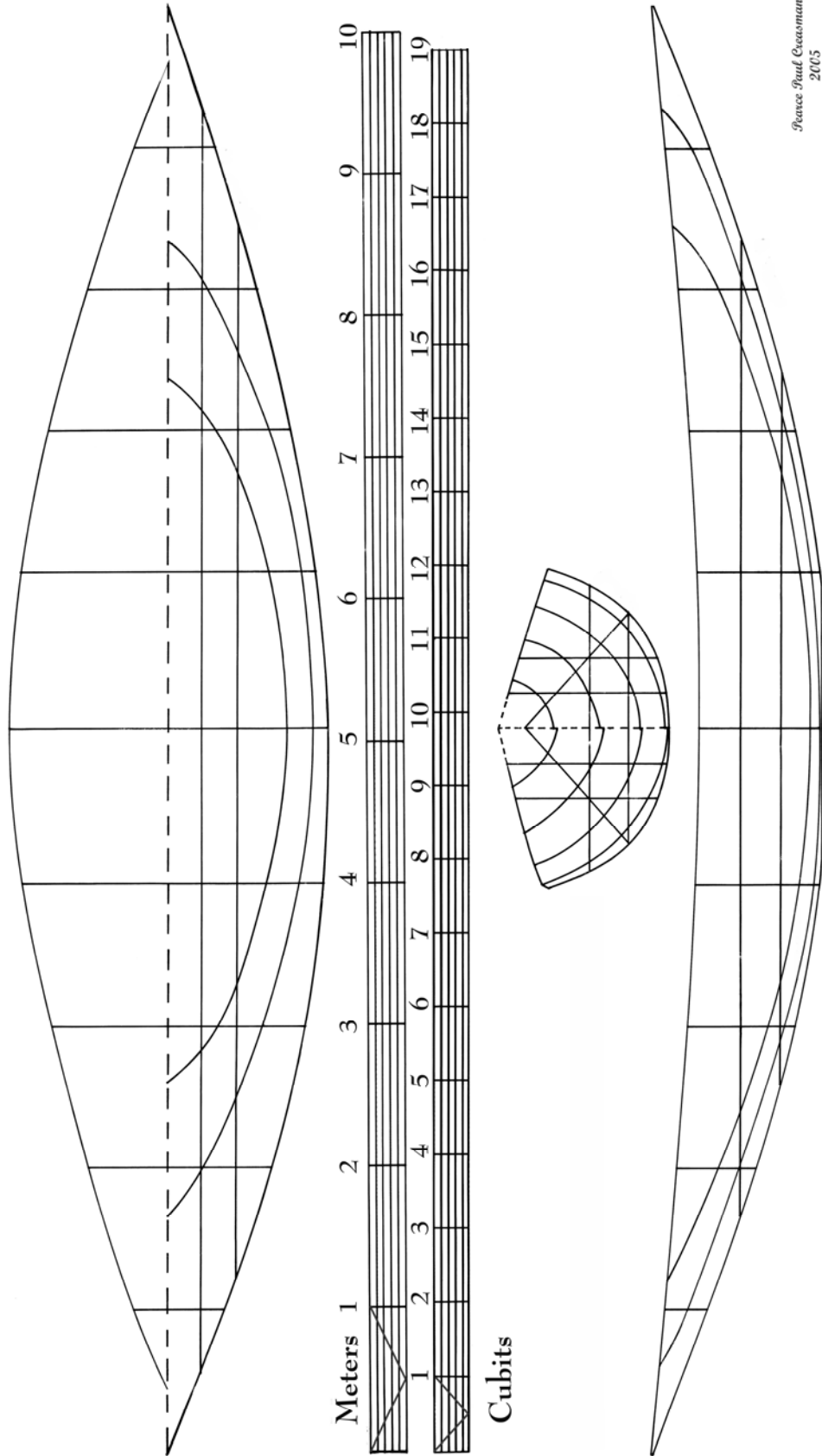

*Peace Paul Crossman
2005*

Figure 15. Hull lines for the de Morgan boat.

the hull's foundation, in addition to preventing it from hogging. Five strakes are built up on each side of the center strake, with eleven throughbeams resting in notches cut out of the third or fourth strake on either side. Fitting was occasionally required on the bottom of the fifth strake to make the beams sit level. Half of the deck planks span one room and are treenailed at their ends to the throughbeams on which they rest. The remaining planks are longer and cover the midships area of the deck; they are treenailed to three throughbeams, and span two rooms. Little deck planking survives, and with the exception of the bow and stern-most pieces and three long planks, only general positioning can be discerned for them.

All timbers exhibit evidence of mortise-and-tenon joinery that provides longitudinal strength and some structural integrity, while dovetail joinery is frequent but limited to the inboard surface of the hull. Evidence of lashing is restricted to strake five and the extreme bow and stern areas.

One quarter rudder is displayed resting across the throughbeams at the bow while another is stored beside GC 4926 under canvas. The pair of quarter rudders is matched by a pair of quarter rudder stanchions inserted through holes in throughbeam 10, and rest in sockets in the strake below. The quarter rudder beam bearing two Horus-head carvings rests at the stern, aft of the stanchions and against strake 5. Short, semi-cylindrical rails on either side at the bow and stern are secured to strake 3 by treenails (Figures 13 and 30).

While in a poorer state of preservation than the Chicago and Pittsburgh boats, the de Morgan boat it is in much better condition than GC 4926. The outer surface of the hull has suffered wear, erosion, insect and fungal damage. A fungus, probably common

wood rot, has done notable damage to some exterior surfaces in patches. Lower strakes are not significantly more deteriorated, but are in worse condition. The boat has been largely unprotected against damage from tourists, tour guides, and the worsening smog of Cairo. Although not as severe in a desert climate as elsewhere the boat is not protected against humidity and temperature fluctuations either. The central strake and starboard side of the bow have suffered the greatest damage; the central strake is missing at least 10 cm at the bow and at least 15 cm at the stern.

Most of the original tenons were removed and an undetermined number were replaced with modern tenons sometime after the excavation. Surprisingly, crude mortises were fashioned in several places to fit the replacement tenons.⁹⁰ Several original fragmental tenons remain locked within the planking but analysis for most would require disassembly of the hull, which was not possible for the purposes of this study. It is also clear that several tenons from the prior use of the hull planking, which predates the construction of the Dahshur boats, remain in their mortises.

Five original throughbeams are supported on top of thin modern beams due to their broken and fragile condition, confirming the number of original beams recorded in Frothingham's report regarding the arrival of this boat at the Gizeh Museum in 1895.⁹¹ All the other throughbeams are modern replacements fitted into their corresponding sockets in strakes 3 and 4, but on at least one occasion the socket was expanded to fit the new throughbeam. Iron bands were secured with screws and iron nails around the hull at

⁹⁰ This is somewhat surprising since this was unnecessary and time consuming work. All planks have many extra mortises from previous ancient uses that could have been used for this purpose. It seems that the replacement tenons were hammered into place, as revealed by the hammerhead impressions at their ends. Some of the tenons were inserted into mortises without a corresponding mortise on the adjacent plank. In such cases, instead of removing the tenon or cutting of the protruding end, and starting again with another tenon, as was done at the stern, new corresponding mortises were cut into the adjacent plank to accommodate the tenon.

⁹¹ 71-2.

each throughbeam, except where the three independent floor cradle supports contact the boat. These modifications were added around 1900, as best can be deduced, "to help preserve the curved shape of the vessel"⁹² while on display in the new museum. In places metal oxides have leached into the adjacent wood. Certainly, this boat contained no metal structural components in its original state.

Traces of a white primer and various colored paints are found all over the hull but in very small, and in most cases minute, amounts. It has been suggested that these coatings were modern applications to make the vessels "appear more ancient."⁹³ However, holes in the hull planking below the waterline, as found on plank C3, were patched in antiquity with a plaster-like substance; most of the evidence for these compounds found at the bow and stern. Additionally, wooden plugs fill several small holes in the hull planking, both above and below the waterline, yet this is rare.

De Morgan notes that when the boats were deposited outside Senwosret III's pyramid complex they were supported by rubble and mud-bricks built up against the sides of the hulls, and the excavation photographs demonstrate this. This practice alleviated the stresses on the boats from supporting most of their own weight for the time they spent buried in the sands. When the boats were removed, they were supported by a simple cradle system probably similar to, if not identical with, the system currently employed in the museum.⁹⁴ Since excavation, the desiccated boats have been bearing the brunt of their own weight. The iron bands must have helped at first but are now compounding the problem and causing the boats to distort dramatically.⁹⁵ The de

⁹² Haldane (1984, 10).

⁹³ Ibid, 10.

⁹⁴ de Morgan 1895, 83.

⁹⁵ See port strake 5, the weather strake, on Figure 14 for a good example of distortion.

Morgan boat has gaps of up to 10 cm wide between planks, and if better precautions are not taken the process of settling and distortion will probably worsen when the boat is next moved.⁹⁶

The information provided in the following description of the de Morgan boat and its associated components was collected during nearly six weeks of observation and recording by the author and his team. Hand-drawn hull lines were drafted from offsets on both sides of the hull at each throughbeam and other critical locations, while the three-dimensional reconstructions were made from at least 19 sections at predetermined intervals, usually each half a meter apart. As in Ward's work on the boats in Chicago and Pittsburgh,⁹⁷ the description that follows is in approximate order of construction.

The strakes have been numbered in like standard from the garboard out (1-5), and each plank has been numbered sequentially from bow to stern. Port and starboard are referenced by "P" and "S," respectively. For example, "S1-2" refers to the second plank (of three) in the first starboard strake. The throughbeams are also numbered sequentially from bow (TB 1) to stern (TB 11), as there is not a traditional midships section from which to denote fore and aft. Rooms between throughbeams are lettered sequentially with the area from the bow to the forward side of throughbeam 1 (A), to the area aft of throughbeam 11 to the stern (L).

Dating

Senwosret III ruled during the 19th century B.C. (1870-1831) and the de Morgan boat certainly dates to this period. To date, no samples have been taken from the timbers

⁹⁶ The opening of a new Egyptian Archaeological Museum, intentionally back at Giza, is expected in the next two years. Plans have been drafted for several possible methods to transport the Cairo Dahshur boats to a new, more controlled environment.

⁹⁷ Haldane 1984.

for confirmation of a date by radiocarbon (14C) or other method of dating. After a lengthy debate my application to the Board of the Egyptian Museum to take samples for dating was passed over as there is not a facility in Egypt that can prepare and test the samples.⁹⁸ It is likely that 14C analysis of the de Morgan boat would yield dates in the range of 1990-1900 B.C., similar to those offered in Haldane regarding the Chicago boat.⁹⁹ These dates precede the death of the pharaoh with whom the boat is associated with by 50 to 150 years. Evidence of reuse is profuse on the de Morgan boat and supports the felling of the timber considerably earlier than the time before Senwosret's death.

Every plank on the hull has many surplus unmated mortises, tempting several researchers to term this vessel "wretched"¹⁰⁰ or "ill-conceived,"¹⁰¹ though these are exaggerations to the point of inaccuracy, based simply on empirical inspection. The excess mortises, several with ancient tenon fragments extant, pre-date the use of the timbers to their current application. Most of the planks in this boat were used, or fashioned for use, in some other structure prior to their employment on the Dahshur hulls. For what purpose the timbers were previously crafted is unknown and cannot be determined at present: dating of the ancient tenons in mortises that do not have a corresponding match would yield the best estimate of when the planks were previously employed.

If the wood used in the hull is in fact cedar, a rare and prestigious material during the 12th Dynasty, re-use of these timbers should not be unexpected. Since Senwosret

⁹⁸ Scientific testing of artifacts in Egypt is informally required to be conducted within national borders. Only very high profile projects or the most reputable scholars are permitted to send samples out.

⁹⁹ 1984, table 1; see also Ward 2000, 83.

¹⁰⁰ Jenkins 1980, 84.

¹⁰¹ Landström 1970, 90.

personally led his armies into battle, these timbers could have been war booty re-assembled for him as a boat to take into his afterlife, or they could have been procured as a result of the increased trade to the eastern Mediterranean under his reign. These details, however, are merely conjectures and will remain so until the wood is identified, is sourced, and burial practices of the Middle Kingdom better understood.

Central Strake

The central strake consists of three planks butt jointed to one another. There is no evidence of convex and concave shaping at butt joints as found on other Dahshur boats.¹⁰² On the inboard surface are the two largest dovetails placed longitudinally over the butt joint of planks C1 to C2 and C2 to C3. The dovetails are modern iron adaptations secured by screwing into place (Figure 16). A large crack in C2, approximately 75 cm forward of the butt joint between C2 and C3, is covered with an iron plate on the interior and screwed into place with five screws. Plank widths are fuller towards midships and taper down to 13 cm and 11 cm towards the bow and stern respectively. Plank thicknesses are more consistent with little tapering, up to 1.5 cm, towards the bow and stern. This is the thickest strake in the hull and its basic dimensions are given in Table 1.

Table 1. Central strake dimensions in meters - de Morgan boat.

Plank	Length	Fwd. Width	Aft Width	Thickness (fore/aft)
C1	3.23	0.13	0.28	0.08 / 0.095
C2	3.86	0.27	0.27	0.095 / 0.095
C3	3.26	0.25	0.11	0.09 / 0.085

¹⁰² Convex and concave plank ends were reported by Haldane (1993, 208), presumably referring to the Carnegie boat, but no distinction was made.

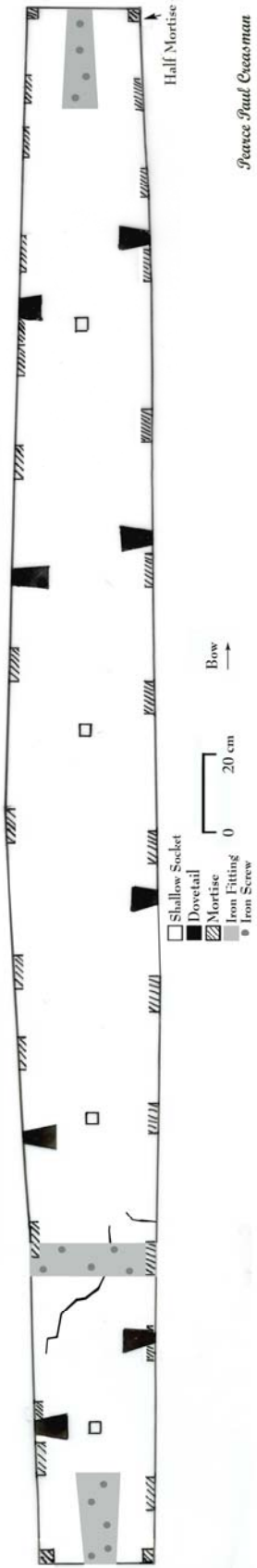

Figure 16. Plank C2 of the de Morgan boat.

Reece Paul Crossman
2005

On the inboard surface of the central strake small dovetails are arranged laterally to secure the garboard planks to the central strake. Frequent deep mortises, measuring approximately 13 cm deep, 7.5 cm wide, and 1.7 cm thick, are arranged in a uniform line near the middle of the planks' thickness in what appears to be at regular intervals, but the presence of many mortises from the planks' previous use could have prohibited the adherence to a uniform pattern of joints. As disassembly of the hull was not permitted, not all mortises could be recorded. Fortunately, many mortises were accessible due to distortion of the timbers over time. Mortises without a corresponding mate on an adjacent plank have been excluded from the study and reconstruction, as they are from previous use of the wood. It was not possible to confirm if mortise-and-tenon joints were used to join the ends of C2 to C1 and C3, although none were apparent.

Peculiar half-mortises situated roughly in the middle of each planks' thickness are present at each corner of the planks where butt joints occur (Figure 16).¹⁰³ The half-mortises measure 4 cm to 6 cm deep, 4 cm wide and 1.8 cm thick. None of these retained any evidence of tenons, nor did they exhibit significant signs of wear. Adjacent planks on either side of the half-mortises do not regularly contain mated mortises.

Small square recesses are present on the inboard surface of each plank in the center strake (Figure 16). The squares measure approximately 2 cm aside and are less than 0.5 cm deep. These recesses on C1 and C3 are not as obvious as those on C2. All square recesses occur nearly centered below throughbeams 4-9, with a slight offset from the centerline of the central strake 3 cm to 5 cm to port. They most likely supported the deck beams. Unfortunately, the thin modern beams supporting the original five

¹⁰³ The half-mortises are probably the same as Reisner's "slot-joint, in end" (1913, 85 and fig. 315). In the case of the center strake the half-mortises are present on both port and starboard, but on all other planks they are limited to the upper side only.

throughbeams obscured analysis of their inboard face and the wood was too fragile to be handled for inspection.

A series of vertical mortises similar to those seen on the Chicago boat¹⁰⁴ were probably present at the bow and stern as well, although C1 is too severely damaged to conclusively state their presence here (Figure 17). At the forward end of C1 is a circular hole, 2 cm in diameter, which penetrates completely through the plank and would have been about half a meter above the waterline when the boat was in use. The hole is somewhat smoothed on the forward three-quarters of its circumference, and appears to have resulted from wear by a rope that had been looped through the hole. The bottom surface of C1 is too degraded to observe if similar wear occurred on this face. The hole is set farther aft on C1 than the vertical mortises in the Chicago and Pittsburgh boats and is shaped differently; it likely served a different purpose.

Mortise pairing on port and starboard sides of the timber can clearly be seen on C1: this trend is common and appears on most timbers in the boat. Half-mortises are also present at the aft end of C1, while the forward end is too degraded to confirm if such features were present. Both molded and sided dimensions gradually decrease at the plank tapers towards the bow.

Dovetails on C1 are standard in size, but unfortunately the area towards the bow was not able to be recorded. The deck planks in the forward-most room are treenailed in place and could not be removed. Additionally, many spare unidentifiable wood pieces, presumably from this boat, are stored underneath the forward room and due to their broken and fragile condition they were not permitted to be moved.

¹⁰⁴ Ward 2000, 85, fig. 36; Haldane 1984, 13-4.

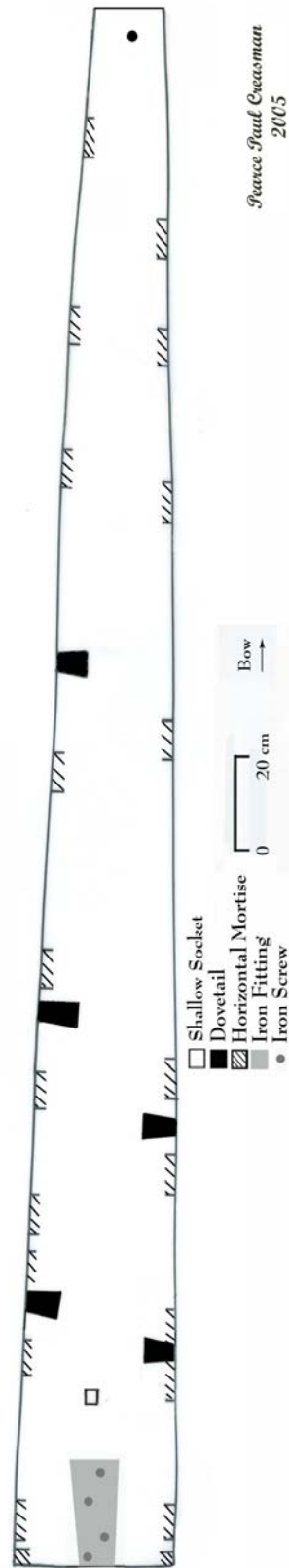

Figure 17. Plank C1 of the Morgan boat.

Planks C1, and to a lesser extent C3, are beveled on one side of their outboard surface. If a section of the planks is represented by a rectangle, then the beveling would best be understood as a removal of one of the lower corners. This beveling creates a flat bottom at least 15 cm wide over the entire length of the boat (Figure 18).

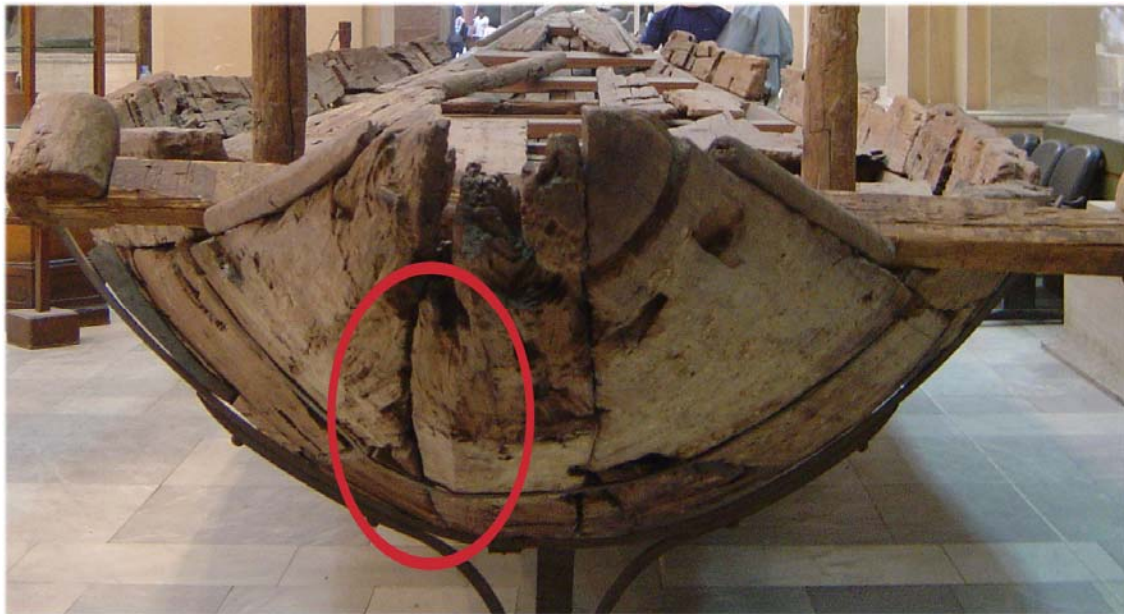

Figure 18. Central strake (C3) outboard beveling at stern of de Morgan boat (J. Levin).

Strake C3 has five rectangular vertical mortises that were cut through the plank during antiquity (Figure 19). They measure approximately 8 cm long by 4 cm wide and four of them retain evidence of an old plaster filling. Each vertical hole retains a mortise passing through it perpendicularly—it is not possible to tell if these mortises were cut by the boat builder or were already extant in the wood used for the boat. One of the dovetails towards the middle of C3 overlaps one of the vertical holes. Additionally, this plank is a good example of an attempt by the boat builder to pair the mortise-and-tenons in neighboring strakes, but mortises from previous uses have made such pairings slightly offset.

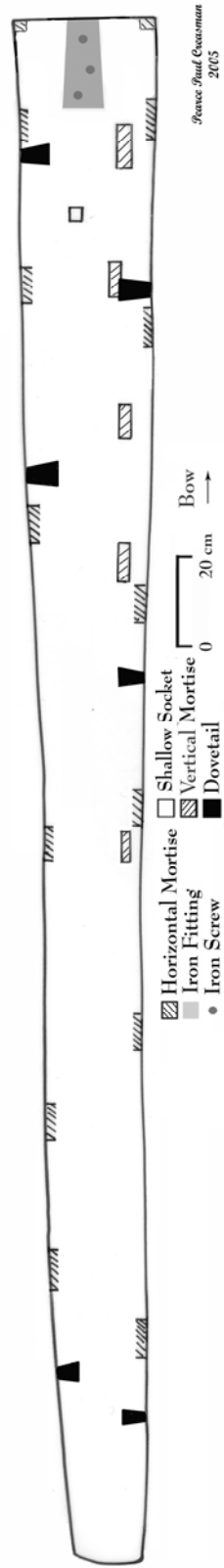

Figure 19. Plank C3 of the de Morgan boat.

Hull Planking

The hull consists of eleven strakes: a central strake and five strakes each to port and starboard. The central strake, strake 1, strake 2, and strake 4 originally each consisted of three planks per side, although damage and repairs over time has altered their former shape. Strakes 3 and 5 consisted of four planks per side, but damage and repairs have taken their toll here as well. All of the planks whose ends were visible revealed that they were hewn from heartwood, or very close to the core of the tree. Each plank follows a straight grain in as much as a curved piece of timber can allow and the sides have supplementary adjacent angles that are nearly equal to one another.¹⁰⁵

All of the 37 planks were smoothly finished on the inboard face and this may have been the same for the outboard faces. The mostly degraded conditions of the outboard faces do not permit a reliable evaluation of primarily the lower planks. Since de Morgan¹⁰⁶ and Reisner¹⁰⁷ reported that both vessels in Cairo were painted on their exterior, it is likely that the outboard surface of the hull was largely finished but left rough to allow a layer of primer to adhere better to the hull. Several of the weather strake planks are in good enough condition for study and their outboard surfaces are less smooth than their inboard surfaces. In describing the strakes, 1, 2, and 3 can all be considered in a similar context, but the design and purpose of strakes 4 and 5 are better discussed independently.

The individual planks in strakes 1, 2, and 3 range in length from 1.7m to 3.9m, with most being approximately 2.5m long. Maximum width is 36 cm, with several

¹⁰⁵ See Haldane 1984, fig. 8 for a discussion of "alternate beveling" and her correction in Ward 2000 (89, n.17).

¹⁰⁶ 1895, 83.

¹⁰⁷ 1913, 83-5.

planks in strake 2 terminating in a point. Thickness of each strake is approximately 0.5 cm thinner on the upper side. For example, strake 1 is 9.5 cm thick on the lower side where it meets the central strake, but tapers to 9 cm on the upper side bordering strake 2. This trend is consistent throughout the entire hull, with 10 cm as the maximum thickness on the central strake; the sides of the center strake taper to 9.5 cm, and each subsequent strake is reduced by 0.5 cm at its upper seam down to 7.0-7.5 cm at the weather strake. The trend is mirrored on port and starboard.

Plank S1-3 also has vertical mortises penetrating completely through the plank (Figure 20). S1-3 presents a much clearer understanding of how such construction challenges were solved in antiquity. Ancient mortises, two of which retain ancient tenons, coincided with the new mortises in order to block the bulk of the earlier tenons and prevent leakage. Staining and residues indicate that the remaining unplugged portions of each ancient tenon was then filled with plaster to ensure water tightness, as the tenons alone would have been insufficient for this task. It is possible that additional caulking material was used but no evidence for this is visible. Half-mortises, identical to those on the central strake, are found consistently on the upper side of each plank where conditions permit inspection, as seen on S1-3 (Figure 20). No signs of wear or use are apparent on the half-mortises.

The butt joint of each strake is approximately parallel to that of the same strake on the opposite end. The butt joints are staggered so that they do not occur at the same location on adjacent strakes. The planks above and below each butt joint exhibit their maximum widths at these locations, giving the hull planking an elongated honeycomb-like construction. This is similar to joggling but is not as drastic and is more aptly

described as fitting. Conversely, the narrowest place of each plank is at its ends or where it terminates its run and abuts the next strake. Further planking symmetry is visible in construction drawings and flattened planking plans (Figures 21 and 22).

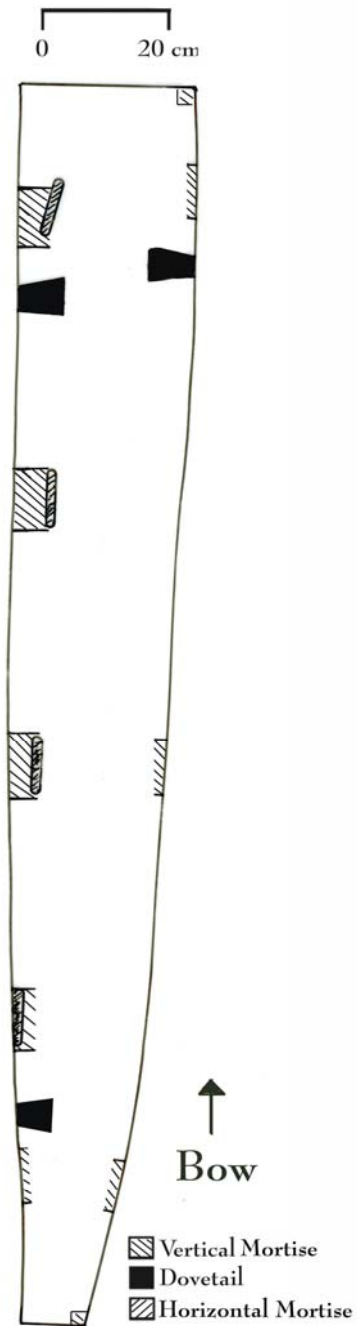
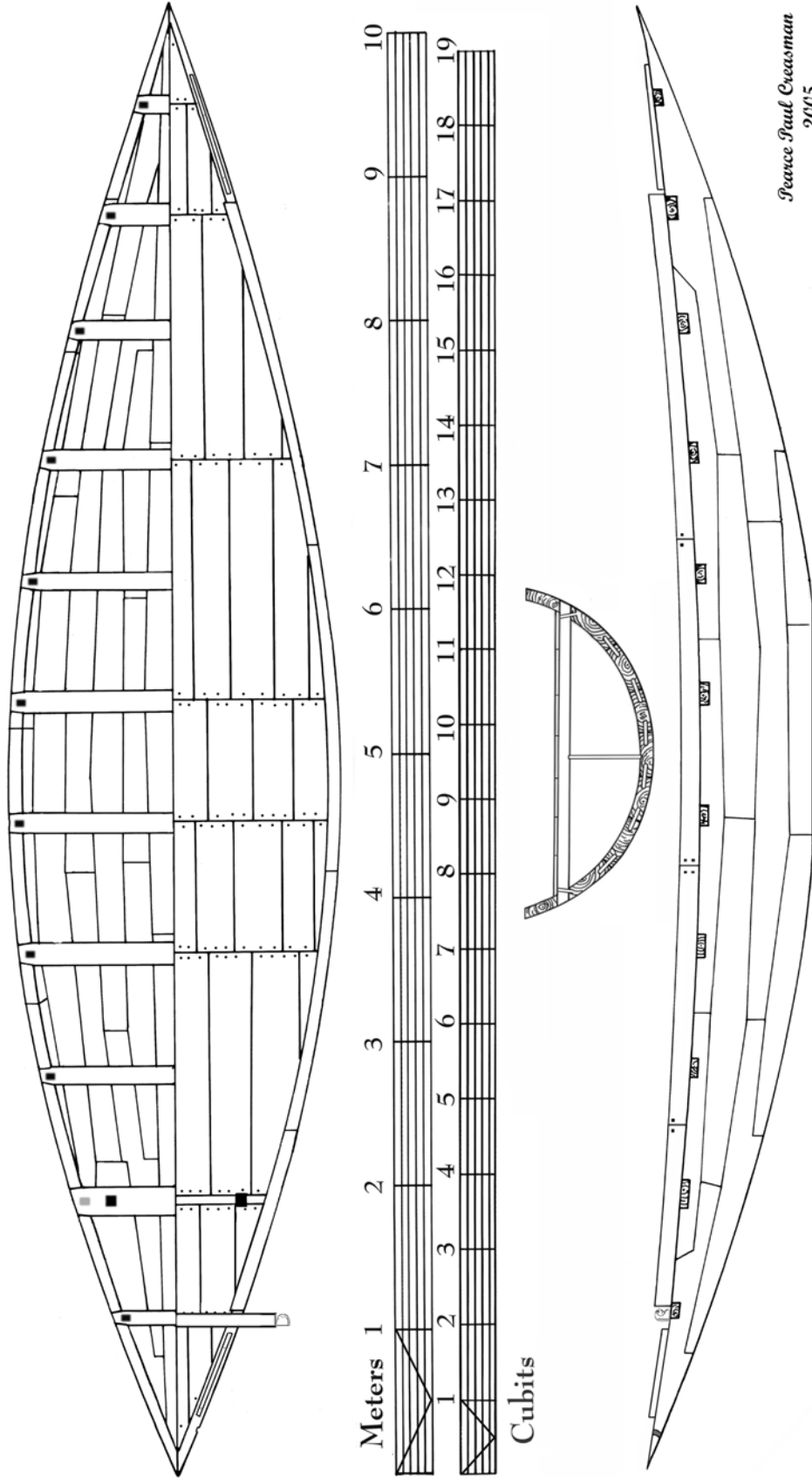

Figure 20. S1-3 on the de Morgan boat (P. Creasman).



*Peuce Paul Creasman
2005*

Figure 21. Construction plans for the de Morgan boat.

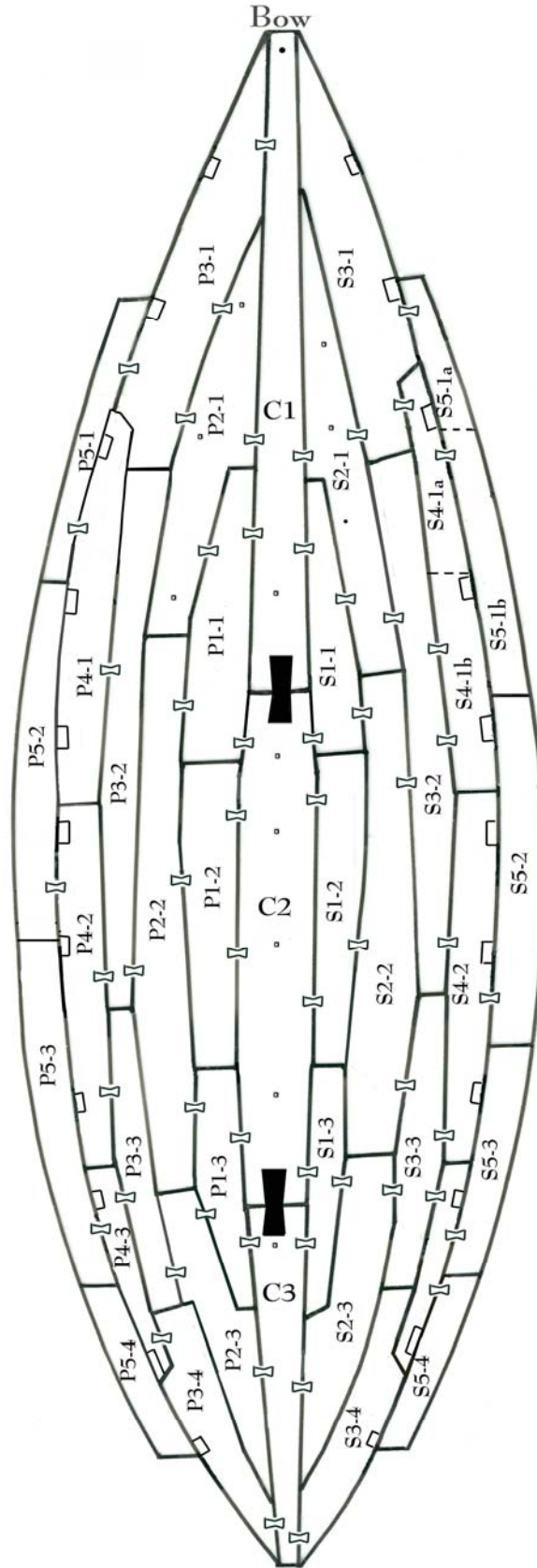

Figure 22. Flattened planking plan of the de Morgan boat - not to scale (P. Creasman).

Table 2 lists principal measurement of each plank in strakes 1, 2, and 3. S2-2 and S2-3 was originally one plank; S2-3 is a modern replacement as is P3-1.

Table 2. Dimensions of strakes 1, 2, and 3 in meters - de Morgan boat.

Plank	Length	Fwd. Width	Aft Width	Thickness (Inboard/Outboard)
P1-1	1.70	0.07	0.30	0.095 / 0.09
P1-2	2.07	0.29	0.24	0.095 / 0.09
P1-3	1.86	0.24	0.10	0.095 / 0.09
P2-1	2.12	0.00	0.18	0.09 / 0.085
P2-2	3.87	0.21	0.29	0.09 / 0.085
P2-3	2.57	0.28	0.00	0.09 / 0.085
P3-1	2.30	0.10	0.33	0.085 / 0.08
P3-2	3.18	0.27	0.21	0.085 / 0.08
P3-3	2.36	0.23	0.18	0.085 / 0.08
P3-4	2.53	0.22	0.00	0.085 / 0.08
S1-1	1.60	0.07	0.29	0.095 / 0.09
S1-2	2.00	0.29	0.28	0.095 / 0.09
S1-3	1.83	0.27	0.12	0.095 / 0.09
S2-1	2.50	0.04	0.25	0.09 / 0.085
S2-2	3.29	0.25	0.31	0.09 / 0.085
S2-3	0.82	0.31	0.31	0.09 / 0.085
S2-4	1.75	0.31	0.08	0.09 / 0.085
S3-1	2.37	0.00	0.24	0.085 / 0.08
S3-2	3.48	0.22	0.17	0.085 / 0.08
S3-3	2.46	0.17	0.19	0.085 / 0.08
S3-4	2.12	0.19	0.00	0.085 / 0.08

Planks S2-1 and P2-1 have small square recesses that are similar to those on the center strake and measure 2 cm square and 0.5 cm deep. However, the two recesses on S2-1 and three on P2-1 are not positioned directly beneath throughbeams. These may have been from previous use or their current positioning compared to those of the throughbeams has been altered by distortion. Also, plank S2-1 contains the only treenail

hole below the waterline in this boat. It measures approximately 1.5 cm in diameter and retains its ancient treenail.

A subject of confusion over the last 50 years has been the presence of what is apparently the only ancient scarf in the hull of any of the known Dahshur boats. Since no comprehensive recording had been produced for this vessel it is no surprise that the written records were incomplete aids in understanding this scarf. Simply described, planks P2-3 and P3-4 are joined at one corner by a "z" scarf (Figure 21).¹⁰⁸

Strake 4 is the only full strake of the hull that is not in contact with the central strake. This strake apparently took the brunt of the damage of the hull over time, as mostly modern replacement pieces occupy its place. While this strake follows the same trends of fitting and narrowing, these are less pronounced. Half-mortises are present in all ancient timbers in this strake on the outboard side.

Table 3 lists principal measurements of each plank in strake 4; S4-1a and S4-1b were originally one plank but both are now modern replacements.

Table 3. Dimensions of strake 4 in meters - de Morgan boat.

Plank	Length	Fwd. Width	Aft Width	Thickness (Inboard/Outboard)
P4-1	1.01	0.05	0.23	0.08 / 0.075
P4-2	2.52	0.23	0.20	0.08 / 0.075
P4-3	2.08	0.20	0.00	0.08 / 0.075
S4-1a	1.30	0.00	0.21	0.08 / 0.075
S4-1b	1.26	0.16	0.23	0.08 / 0.075
S4-2	2.59	0.23	0.26	0.08 / 0.075
S4-3	1.73	0.26	0.00	0.08 / 0.075

¹⁰⁸ This is the scarf that Ward (1984, 75), Göttlicher and Werner (1971, pl. 44), Landström (1970, fig. 275), and Reisner (1913, fig. 313) illustrate.

Strake 5 spans the deck area between throughbeams 2 and 11, and rests on top of the throughbeams. Like strake 4, strake 5 is narrowly a strake by definition. While strake 4 is a structural component critical to the integrity of the hull, strake 5's structural importance is questionable, prompting it to be labeled over the years as a bulwark, gunwale, or simple decoration. A better term for this line of planking is probably "weather strake."¹⁰⁹

Each side of the weather strake consists of four planks that are mirrored on both sides, meaning that P5-1 is nearly identical to S5-1, P5-2 favorably compares with S5-2, and so on. Visual examination of the wood grain of the paired planks suggests that both were cut from the same tree, but this would have to be confirmed by dendrochronological analysis. Whether or not more than one pair of matching planks came from a single tree is unknown. Table 4 lists principal measurement of each plank in the strake 5; S5-1a and S5-1b likely were originally one plank but a break now divides them. P5-2 has some recent patchwork from the 1999 repair project by Atlanta's Michael C. Carlos Museum.¹¹⁰

Table 4. Dimensions of strake 5 (weather strake) in meters - de Morgan boat.

<u>Plank</u>	<u>Length</u>	<u>Fwd. Width</u>	<u>Aft Width</u>	<u>Thickness (Inboard/Outboard)</u>
P5-1	1.58	0.14	0.19	0.075 / 0.075 - 0.07
P5-2	2.53	0.20	0.20	0.075 / 0.075 - 0.07
P5-3	1.97	0.14	0.16	0.075 / 0.075 - 0.07
P5-4	1.54	0.21	0.14	0.075 / 0.075 - 0.07

¹⁰⁹ J. Richard Steffy (1994, 281) defines a strake as "a continuous line of planks running from bow to stern."

¹¹⁰ In 1999 conservators from the Carlos Museum at Emory University worked with the Restoration Department of the Egyptian Museum to carry out *brief* repairs on several wooden artifacts, including both Cairo boats.

Table 4 continued.

<u>Plank</u>	<u>Length</u>	<u>Fwd. Width</u>	<u>Aft Width</u>	<u>Thickness (Inboard/Outboard)</u>
S5-1a	0.64	0.06	0.13	0.075 / 0.075 - 0.07
S5-1b	1.24	0.18	0.17	0.075 / 0.075 - 0.07
S5-2	2.77	0.18	0.20	0.075 / 0.075 - 0.07
S5-3	0.73	0.21	0.17	0.075 / 0.075 - 0.07
S5-4	1.32	0.20	0.17	0.075 / 0.075 - 0.07

The weather strake is attached to the rest of the boat by three fastening methods; mortise-and-tenons, dovetails, and lashings. As the mortise-and-tenons and dovetails are frequent throughout the vessel they will be discussed in the section below regarding fastenings. No lashing, rope, or fiber still exists in any of the lashing holes.

The lashings on the weather strake are intended to secure one plank to another in the same strake. Between the planks that comprise the weather strake, the lashings overlap the butt joints, adding considerable strength. The lashings rested in recessed grooves, 1.7-2.0 cm deep, on both the inboard and outboard face of the planks. Lashing cuts consist of one hole at the joints of 5-1/5-2 and 5-3/5-4, and double holes at 5-2/5-3 on both port and starboard. All of the recessed grooves are parallel to the center line of the planks except the outboard recesses of double lashing holes, which are perpendicular. The fore and aft most ends of the weather strake were surely lashed to the main hull in some manner, although no obvious evidence for the attachment exists on either the plank ends or the corresponding planks.

Half-mortises at butt joints and empty regular mortises are frequent on the top of the weather strake. Two mortises still contain traces of what appear to be plaster filling, as found in other areas of the hull.

The stern-most planks of the weather strake are notched to receive a crosspiece, creating a small protrusion. The crosspiece, while resting on the protrusion was secured directly to strake 3 by square pegs with heads measuring 2.5 cm by 3 cm (depth could not be measured) and has Horus-head carvings attached to each end. A quarter rudder on either side would have rested on the top edge of the crosspiece and would have been lashed in place.

Throughbeams and Deck Planking

Eleven lateral throughbeams stiffen the hull and support the deck planking. The surviving original throughbeams, 4, 7, 9, 10, and 11, are rectangular in section, not recessed or rabbeted on their top surface like those on the Chicago, Pittsburgh, and GC 4926 boats (Figure 23). All throughbeams rest flush in notches cut into strake 3 or 4. Throughbeams 1, 2, and 11 are notched into the top surface of strake 3, and are underneath the semi-cylindrical rails; all others rest in strake 4 and are underneath the weather strake. Shaping was occasionally required on the bottom of the fifth strake to make the beams sit level but it is unclear if this is a modern or an ancient adjustment. The width of each original throughbeam begins to narrow about 10 cm in from each end and gradually reduces by approximately 2 cm (Figure 24). While throughbeam 10 also exhibits narrowing at its ends, it is much less pronounced than in the others, tapering only by 0.5 cm. Narrowing at the ends is inconsistent on modern or reconstructed throughbeams.

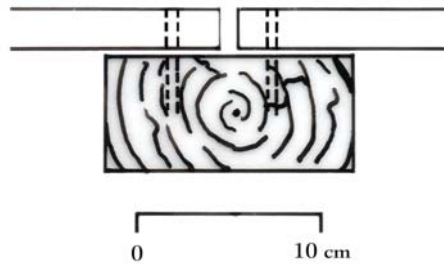

Figure 23. Section of a throughbeam with treenailed deck planking from the de Morgan boat (P. Creasman).

Each throughbeam is spaced approximately 70 cm apart and its ends are flush with the outer surface of the hull. Throughbeam 11 protrudes slightly from the outer surface of the hull but this is due to distortion over time. The wood-grain of all throughbeams runs parallel with the length of the beam.



Figure 24. Starboard end on throughbeam 4 of the de Morgan boat showing narrowing (P. Creasman).

Around midships and in the aft part of the boat the throughbeams have noticeably more substantial thicknesses, corresponding to slightly fuller sections aft of midships. For modern replacement, throughbeams' principal measurements were taken from the notches in which they would have originally rested and the distance they would have spanned (Table 5).

Table 5. Dimensions of throughbeams and rooms in meters - de Morgan boat.

Throughbeam	Length (Fore)	Length (Aft)	Length (Ave)	Width	Height (Thickness)	Increment to Next Face (Room)
TB1	0.58	0.63	0.61	0.13	0.045	From bow to foreTB1 0.64m
TB2	0.97	1.50	1.24	0.17	0.045	Aft TB1 to fore TB2 0.62
TB3	1.35	1.37	1.36	0.14	0.045	0.66
TB4	1.75	1.76	1.76	0.14	0.045	0.76
TB5	1.90	1.91	1.91	0.14	0.045	0.71
TB6	2.00	2.00	2.00	0.15	0.06	0.70
TB7	2.04	2.03	2.04	0.12	0.06	0.70
TB8	1.98	1.98	1.98	0.15	0.06	0.76
TB9	1.86	1.85	1.86	0.11	0.055	0.70
TB10	1.45	1.38	1.42	0.20	0.055	0.71
TB11	0.94	0.92	0.93	0.09	0.035	0.66
						Aft TB11 to Stern 1.06

The throughbeams were originally fastened to the strake in which they rest by rectangular treenails, approximately 2.5 cm x 3 cm of unknown lengths; none of the rectangular treenails have survived. The treenail perforations did not originally penetrate the hull completely, but due to breakage they do so today.¹¹¹ Damage, reconstructions, and particularly the iron bands obscure or otherwise make it difficult to ascertain if the treenail pattern is consistent on each throughbeam. There is evidence on at least one end

¹¹¹ See Reisner's 1913 recording, specifically figs. 318 and 319.

of each throughbeam or its associated strake below, for the presence of rectangular treenails excluding throughbeam 11 which is completely obscured. The square hole on the port end of throughbeam 10 that receives the rectangular treenail is incomplete as it does not completely penetrate the throughbeam.

Throughbeam 10 stands out from the others in several respects, one reason already mentioned above. The width is significantly greater than that of all the others and in several cases nearly two times as wide. The quarter rudder stanchions pass through large square sockets measuring approximately 7.5 cm square, about 25 cm in from the ends of the throughbeam. Surprisingly, this is not the thickest throughbeam in the hull. Additionally, this timber has evidence of charring and burning on its forward side at the port rudder stanchion. There is no indication of when this burning took place, yet, it was not uncommon for workers to burn wood from an excavation in the late 19th century.¹¹² If de Morgan caught wind of this he would have immediately prevented the timbers from being burned, thus preserving what remained. It is possible that the charring occurred sometime after the excavation, but it is unlikely that this would have escaped documentation in the museum. It is also possible that the charring occurred before the boat was deposited in the sands at Dahshur, but there is no archaeological or cultural evidence to suggest this.

All of the preserved throughbeams have numerous small peg holes, 1 cm or less in diameter, as evidence of their receiving pegs to secure the deck planking.

Throughbeams 4, 7, and 9 are broken in half near their centers, generally above the recessed square holes in the center strake mentioned above (Figure 25).

¹¹² The site of Dahshur was at least 8 kilometers from the Nile at the time of excavation. Being that far from the water, it is unlikely that much wood was available for fuel in the immediate surrounding area; photographs from the turn of the century confirm the scarcity of plant life in the region.

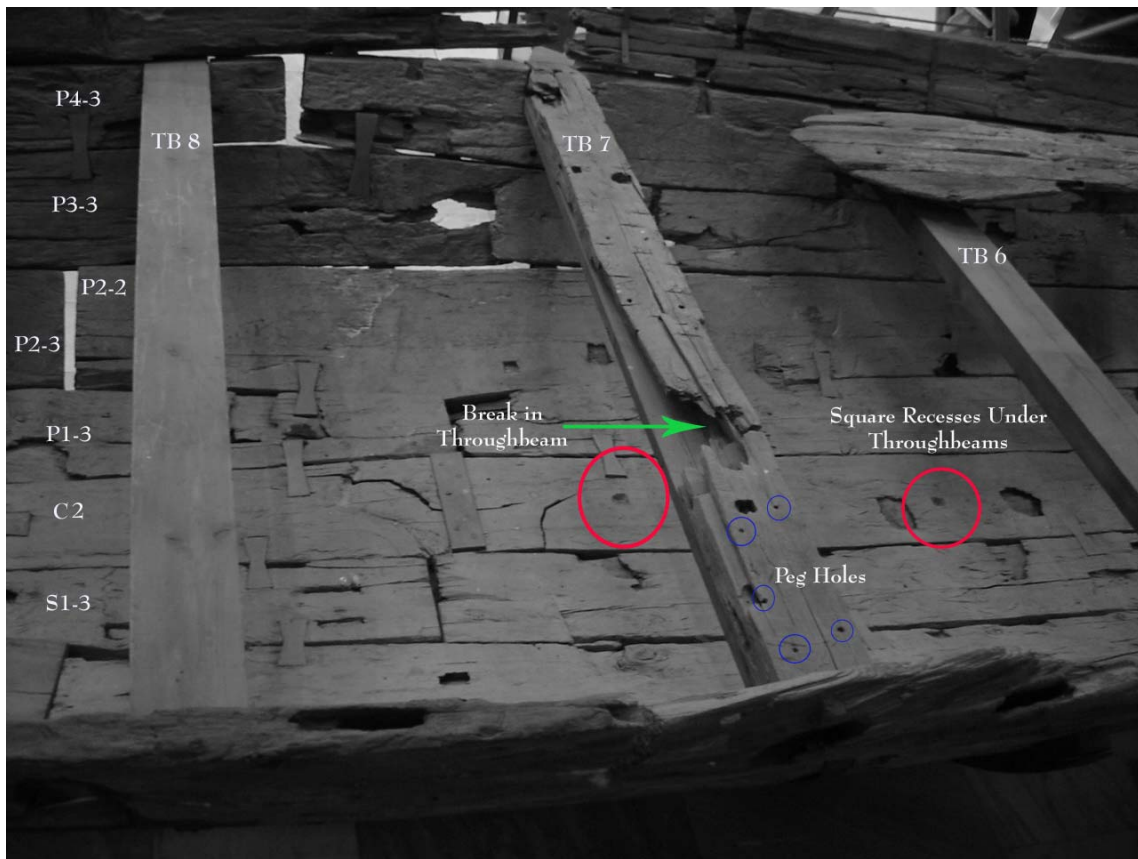

Figure 25. Interior of the de Morgan boat, from starboard (P. Creasman).

Deck planking originally covered all 12 rooms and was attached by pegs. Twenty-four planks remain, most planks span only one room, but the longer planks cross two rooms. The outermost deck planks in each room, that is those bordering the hull, are beveled on their outboard edges in order to lie flush with other deck planks and the top of the hull. All deck planks rest on top of the throughbeams or directly on the hull, as is the case in rooms A and L. The planks in section 1 (room A), 5 (room K), and 6 (room L) are in their original locations while the other planks rest where they are best supported to prevent further breakage. Unfortunately, exact placement of many planks

cannot be determined as they are shifted around by the museum staff from time to time, and the restorers are hesitant to use any adhesive labeling system to identify them.¹¹³

Currently, the planks are arranged in roughly six clusters, or "sections," on top of the throughbeams. The "sections" have been used by restorers for an unknown length of time for reference purposes, so no exact labeling system has been established. Thus, each section was labeled numerically from bow (1) to stern (6), and each plank was lettered from starboard (a...) to port (...z). Each section and plank was photographed and catalogued.¹¹⁴ Table 6 lists principal measurement of each plank.

Table 6. Dimensions of deck planking in meters and frequency of pegs and mortises.

	Length	Width	Thickness	# of Pegs	# of Mortises
		Bow/Mid/Stern	Bow/Mid/Stern		
Section 1					
a	0.46	0.15/ 0.20	0 tapered to 0.025	2	0
b	0.38	0.17/ 0.19	0 tapered to 0.03	2	0
Section 2					
a	1.42	0.01/ 0.27/ 0.23	0.03/ 0.035/ 0.02	2	5
b	1.76	0.22/ 0.23/ 0.24	0.035-0.045	2	3
c	1.00	0.22/ 0.22/ 0.23	0.035-0.04	2	2
Section 3					
a	1.49	0.28/ 0.29/ 0.29	0.025	0	6
b	1.65	0.29/ 0.31/ 0.30	0.04/ 0.04/ 0.045	3	8
c	1.79	0.33/ 0.33/ 0.33	0.04	3	6
d	1.32	0.25/ 0.24/ 0.24	0.035	6	8

¹¹³ It is difficult to reconcile the proper nautical terminology and system of labeling (rooms) with what is currently being practiced at the museum. As the catalogues were designed for use at the Egyptian Museum, this thesis will employ the Museum terminology first, followed by standard archaeological terminology in parentheses. To help avoid confusion, rooms are designated by capital letters and individual planks by lower case letters only.

¹¹⁴ Catalogues are housed by the Egyptian Museum and the Institute of Maritime Research and Discovery; they should be published by 2006.

Table 6 continued

	Length	Width Bow/Mid/Stern	Thickness Bow/Mid/Stern	# of Pegs	# of Mortises
Section 4					
a	1.52	0.26/ 0.22/ 0.15	0.03/ 0.03/ 0.035	16	5
b	1.54	0.30/ 0.28/ 0.28	0.035/ 0.05/ 0.035	13	13
c	1.59	0.26/ 0.26/ 0.25	0.045/ 0.04/ 0.04	2	6
d	1.65	0.26/ 0.25/ 0.23	0.04/ 0.02/ 0.045	2	4
e	1.83	0.28/ 0.29/ 0.26	0.035	1	13
f	1.66	0.24/ 0.25/ 0.24	0.02/ 0.025	4	10
Section 5					
a	0.77	0.23/ 0.18	0.03/ 0.025/ 0.3	10	0
b	0.70	0.16/ 0.14/ 0.11	0.035/ 0.03/ 0.25	2	2
c	0.78	0.19/ 0.16/ 0.12	0.04/ 0.025/ 0.02	3	0
d	0.82	0.15/ 0.13/ 0.11	0.04/ 0.03/ 0.025	2	2
e	0.83	0.26/ 0.24/ 0.22	0.03/ 0.03/ 0.02	4	0
f	0.82	0.25/ 0.19/ 0.15	0.04/ 0.015	3	0
Section 6					
a	0.47	0.10/ 0	0.03/ 0.025/ 0.015	1	0
b	0.69	0.13/ 0.11/ 0	0.03/ 0.025	1	0
c	0.65	0.12/ 0.08/ 0.04	0.03/ 0.025	2	0
d	0.73	0.20/ 0.14/ 0.06	0.035/ 0.025/ 0.015	2	0

The shorter planks are in very good condition while longer planks are in poor condition and often times quite fragile. All planks are finished on the top surface and partially finished on the bottom; many planks still bear clear adze and chisel marks. Ancient mortises that have been heavily damaged are frequent on the underside of most planks. The frequency of mortises alone provides sufficient chance for several to line up coincidentally with those on adjacent planks, but a distinct pattern, similar to that seen in other construction elements of the boat, presently cannot be determined. The evidence is

insufficient to conclude if the deck planks were edge joined by mortise-and-tenon as recorded by de Morgan and Reisner.¹¹⁵

Plank length ranges from 0.38 m to 1.89 m depending on its intended position on the boat. Two general divisions are apparent: short planks, measuring around 0.75 m, and long planks, measuring at least 1.5 m, with significant variation outside these general lengths due mostly to breakage. Plank width varies from 10-30 cm mostly depending on placement in the boat, warping, breakage, and desiccation. Plank thickness is intentionally varied on each plank, depending on shaping on the underside and prior usage of the wood.

Fastening and Joinery

Mortise-and-tenon joints, dovetail fastening, and lashings are present in the de Morgan hull. As noted by Haldane, the Dahshur boats exhibit use of the earliest known examples of deep mortise-and-tenon joints in watercraft construction.¹¹⁶ Much debate has centered on the authenticity of the Dahshur dovetail fastenings: are they ancient or modern? If they are indeed ancient, then they would be the first and only ancient examples of this fastening method applied in watercraft to provide significant structural integrity to the hull.¹¹⁷

Mortises (Figures 6 and 7) 7.3-7.9 cm wide, up to 15 cm deep and less than 2 cm thick are cut into the lower and upper sides of the hull planking.¹¹⁸ All planks have evidence of frequent mortise-and-tenon joinery, which makes the hull *appear* in worse

¹¹⁵ de Morgan 1895, 82; Reisner 1913, 83.

¹¹⁶ 1984, 23.

¹¹⁷ I am not aware of any other ancient or historical craft that frequently makes use of dovetails to provide structural support. However, there are several types of vessels from Aswan and eastern Africa from the last 100 years that used this method as fastenings.

¹¹⁸ Half-mortises in butt joints were discussed above.

condition and to be of poor craftsmanship, when in fact they were well designed and executed. Most of the mortises are from prior use in ancient times, as suggested by the presence of unmated mortises and tenons. Evidence of a plaster coating in several mortises indicates that they were plugged or still retain parts of their original tenons. Inspection revealed chisel marks of two sizes: the standard chisel for cutting mortises was about 0.5 cm wide, but a larger one of 1.2 cm wide was used as well. Most mortises have nearly flat bottoms and are close to rectangular in section. Since the hull could not be disassembled, not all mortises were examined, but since little variation was found among those studied, such measurements are probably relatively consistent among them. Some mortises are slightly wedge-shaped in section, but this is not common.

At least three mortises were measured under each throughbeam and in each strake, revealing that mortises in the forward half of the vessel are 0.75 cm to 1.25 cm shorter than those amidships and slightly aft. Mortises at the stern of the boat have nearly identical dimensions to those in the bow. All mortises appear to be regularly spaced along plank sides, but mortises from the plank's previous use limited the regular placement of new mortises, thereby preventing the application of a precise mortising pattern.¹¹⁹ Mortise-and-tenon joints were probably intended to be 60-70 cm apart. There is no evidence for the use of slips to tightly secure tenons, in place as found by Ward in the Middle Kingdom Lisht timbers.¹²⁰

Tenons would have fit snugly into the mortises; their dimensions are equal to or slightly larger than the accompanying mortises which were hammered in place. Several ancient tenon fragments are still locked in the de Morgan boat but none could be

¹¹⁹ Haldane (1993, 210) recorded a pattern of mortises near joints and every 10-15 cm on the center strake and every 60 cm (1984, 24; Ward 2000, 86) in the remainder of the hull of the Chicago boat.

¹²⁰ Ward 2000, 118-20 and fig. 62; see also Ward 2004, 18.

completely removed. The wood used for tenons is noticeably darker than that of the rest of the boat and may have been coated in a tar or pitch.¹²¹ Evidence of a tar or pitch is frequent in the mortises and on the ancient tenons as is a grey ash-like substance and dark staining. Chemical analysis of these substances may be able to determine their origin and hence suggest their purpose. Ash and staining also occur on significantly degraded ancient tenons lodged in place, indicating that these substances can not be modern applications. However, on several tenons on the upper strakes there is evidence of application of a modern black tar or adhesive. All tenons currently holding the vessel together are of modern manufacture and many have a dark brown or black coating. Museum records conflict as to the purpose of these modern coatings, but it is clear that the black coating is an adhesive tar and the brown is a preservative stain of some kind.

Six of the eight planks at the ends of strakes 2 and 3 terminate on points, two of which have a mortise-and-tenon joint securing the strake through two adjacent planks.¹²² This technique is consistently found on the Dahshur boats in the U.S., but this is not the case with the de Morgan boat.

Rarely, dovetails (Figures 8 and 9) are placed directly over a mortise-and-tenon joint (Figure 26). Since such a practice weakened the mortise, the dovetail, and the surrounding wood, a dovetail overlapping an ancient mortise is likely indicative of a modern application.¹²³

¹²¹ The ancient tenons were probably fashioned from *Tamarix* sp., as they resemble those from the boat in the Carnegie Museum, Pittsburgh (Ward 2000, 92).

¹²² See Haldane 1984, fig.10; see also Steffy 1994, fig. 3-13.

¹²³ Some time since excavation in 1894, but before 1913.

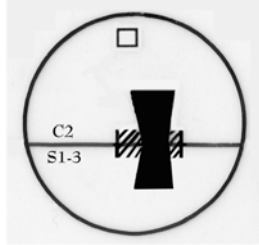

Figure 26. Dovetail overlapping an ancient mortise on the de Morgan boat (P. Creasman).

At least one and usually several dovetails join each plank in the hull to another; only P5-4 is devoid of dovetails. Dovetail joints cross planking seams laterally. There are only two exceptions to this, those at the butt joints of C1 to C2 and C2 to C3, which are the only iron dovetails on the boat and also the only ones aligned longitudinally. The frequency of dovetailing decreases in each strake the farther the strake is away from the center strake. A typical dovetail measures 13.0-16.5 cm long, 5.2 cm wide at the ends, 2.4-3.0 cm narrow at the middle, and 2.0-2.5 cm deep. Each dovetail is custom shaped to fit its place in the boat, with those at the ends being the most drastically angled in wide "V" shapes. Dovetails are spaced on average 75 cm apart, but may be as close as 50 cm and as wide as 95 cm apart at the stern port quarter. All of the dovetails themselves are modern replacements, but the same cannot be said for the sockets in which they rest.

Lashings are present in the de Morgan boat in two distinct forms: weather strake lashings that have were mentioned above and hull lashings. Lashings on the main body of the hull serve the same purpose as those on the weather strake but are more obscure. A deep groove at the stern of the boat (Figure 17) has been mentioned in almost every report regarding this boat, and is assumed to have held lashings for a finial, although there is no definitive evidence for the existence of such a finial. De Morgan may have provided evidence of a finial by illustrating support pieces at the bow (Figure 12) but his

is the only recording. Finials almost certainly existed, although the specific style is unknown.

Mortise-like cuts in the bow and stern align with one another, following the section of the boat and probably retained lashings (Figure 27). The series of mortise-like cuts are smooth on their interior as if they had been worn smooth by ligatures, and have no signs of tar, ash, or pitch. The bow, just below where the presumed finial would have rested, is badly eroded and this may have eroded any further evidence regarding the attachment of a finial.

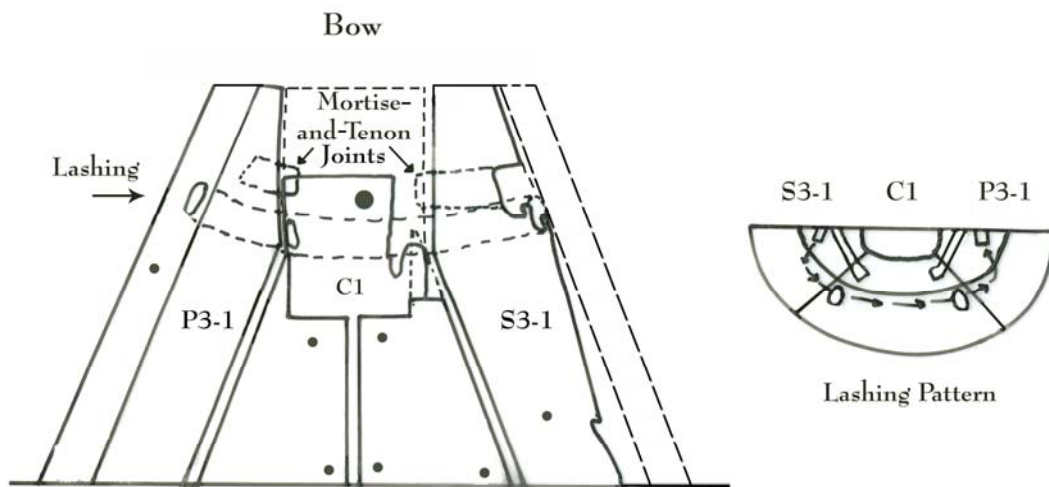

Figure 27. Lashing pattern in the bow of the de Morgan boat (P. Creasman).

Iconography from 12th-Dynasty sites has much to offer in interpreting finials and other ornamentation on boats. For example, wall paintings in tomb 2 at Beni Hassan from the time of Senwosret I's reign are most pertinent and particularly informative regarding craft similar to the Dahshur boats.¹²⁴

¹²⁴ See Appendix E; Tomb 3 at Beni Hassan, belonging to Khmunhotep III, is often credited as depicting a reliable Middle Kingdom shipbuilding scene, but inconsistencies in the published representation and interpretation of associated hieroglyphs for the last century usually conflict with the image in the tomb itself.

Ward has proposed that the dovetails were, in fact, never dovetails, but modified lashing cuts similar to those known in other ancient Egyptian ships.¹²⁵ The evidence Ward uses to support this theory is not, however, found on the de Morgan boat, and will be addressed in the *Analysis* section below.

Tool Marks

Several types of tools typically associated with the Middle Kingdom can be identified by their remaining marks and impressions on the Dahshur boats.¹²⁶ Plank ends reveal the use of saws in both ancient times and modern. Ancient saw marks are smoother, spaced farther apart, and have not left burn marks. Modern saw use is evidenced by extremely jagged ends on the cuts, friction burns from the blade, and by the sort that the cuts are restricted to butt joints next to a modern replacement piece, particularly in the forward port quarter of the hull.

Evidence of hammering is also present on both modern and ancient construction. Round impressions from standard or ball-peen hammers appear to be restricted to the top of strakes and to modern tenons. Crosshatched impressions detailed in Figure 28 are similar to the head of a ceremonial metal hammer found in the Egyptian Museum dating to the late 13th Dynasty.¹²⁷ These impressions are found between planks and always near an original mortise that has a mate on the adjacent plank. While the impression matches

¹²⁵ See Ward 2000 (93-5) for clearest presentation of the dovetail/lashing issue.

¹²⁶ See Davies (1987), Sliwa (1975), Goodman (1966), and Petrie (1916) for examples of ancient woodworking tools.

¹²⁷ Wooden hammers were standard during the Middle Kingdom. Using a metal hammer on wood can cause significant structural problems and is, therefore, rare.

well with the head of the ancient hammer, this pattern is also common on modern clamps that were used when assembling or disassembling the hull.¹²⁸



Figure 28. Close up of a cross-hatched impression at a mortise on the de Morgan boat (J. Levin).

Impressions on top of ancient tenons correspond to the size and curvature of several wooden mallets associated with the Middle Kingdom.

As mentioned above, chisel marks are found inside mortises and adze marks can be seen on the outboard surfaces of most hull and deck planks. Chisel and adze marks are also found on the quarter rudder stanchions and throughbeams.

Steering Arrangement

The steering arrangement of the de Morgan boat is of a standard type for Egyptian funerary craft. Representations, boat models, and other sources from the

¹²⁸ Similar cross-hatching markings were found on the Pittsburgh vessel (Haldane 1984, 62-4).

Middle Kingdom reveal a standard of one quarter rudder on either side of the stern—the de Morgan boat is a life-size testament to this trend.

Each quarter rudder was secured to the boat at two points, and probably three points. In order to secure the quarter rudder, the rudder loom was lashed at about three-quarters of the way up to the top of the stanchion, with the bottom of the loom resting on the upper aft edge of the crosspiece; the blade was tethered to the boat. It is uncertain if the blade was tethered directly to the hull or if it was tied to the crosspiece: both methods are practical and serve the same function. The top of the loom may have rested on an upper crosspiece that was secured between the two stanchions, but the lack of features near the top of the quarter rudder stanchions suggests otherwise.

The de Morgan boat has two quarter rudders; that which currently is stored on deck measures 3.6 m long, has a blade length of 1.2 m, and originally consisted of three pieces: a long central piece and two wings affixed on either side (Figure 29). The loom is straight, circular in section, with maximum diameter of 10 cm at midpoint and was shaped from the core of a tree. Approximately one meter from the top of the blade, the loom begins to flatten slightly from its round section. At the point where the loom and blade meet, the section is noticeably more rectangular, ending in a wedge shape at the rounded tip. The blade's wings are fixed to the central loom with at least three pegged mortises and tenons per side, measuring 7.5 cm wide and 1.8 cm thick, with varying lengths. Original paint remains on several pegs indicate that both the pegs and the tenons are original. One wing of the blade has a 2.5 cm x 2.7 cm hole cut through it about 40 cm from the top. A rope would have run through this hole to secure the quarter rudder to the vessel.



Figure 29. Blade of a quarter rudder (J. Levin).

A square post 8 cm tall by 3 cm square is carved out at the top of the loom, without doubt to accept a carving of a Horus-head finial.¹²⁹ Seventy-nine centimeters below the top of the square post on the loom is a 4 cm tall by 5 cm wide square socket angled downward at roughly 45 degrees. This socket would have held a tiller similar to the one stored under a canvas with the boat's second quarter rudder. The other quarter rudder is in extremely fragmented condition, but resembles the previous and measures approximately 3.50 m long with a blade length of 1.15 m. It is sufficient to note that the second quarter rudder has roughly the same features as the better preserved one, including the tiller socket, and a tether perforation in the upper portion of a blade wing.

¹²⁹ de Morgan 1895, pl. XXXI.

A hole with similar dimensions to the rope tether perforation in the upper part of the blade wings is found in planks P3-5 and S3-5 underneath where the crosspiece is found.

The two quarter rudder stanchions measure 1.71m and 1.70 m in height but both have received modern modification at their tops (Figure 30). At the top they are round in section gradually changing into a square section about 50 cm above where they pass through sockets in throughbeam 10. The diameter of the rounded area is approximately 10 cm and the width of the square area is 12 cm. Both stanchions fit snugly through throughbeam 10 and rest in shallow divots fashioned in the hull plank below.



Figure 30. Stanchions on the de Morgan boat, from stern (P. Creasman).

These stanchions do not appear to be a matching set.¹³⁰ The port stanchion has been modified flat at its top and has a plugged mortise 10 cm below its apex that is 7 cm high by 2 cm wide. Another plugged mortise with the same dimensions exists 72 cm below the apex. At deck level is a large hollow through the middle of the stanchion 15 cm high and 3 cm wide. The starboard stanchion has half of a square peg fashioned at its top, measuring 8 cm high and 3 cm wide. Two small mortises, 3 cm high by 2 cm wide by 3.8 cm deep are located 29 cm and 104 cm from the top, respectively. Also, a "z" scarf is located about 20 cm above deck level joining two independent timbers. The scarf is a modern repair, as is the lower portion of the stanchion that passes through throughbeam 10 and rests in the strake below.

Ornamentation

Horus-head carvings capped the tops and ends of all rudders, stanchions and crosspieces (Figure 31). With the sun for one eye and the moon for the other, Horus was the god who guided and protected the pharaoh on his journey through night and day into the afterlife, so it should not be surprising that its presence on the boat was significant.

Two Horus-head carvings are currently on display with the de Morgan boat, nailed and glued to the reconstructed crosspiece resting aft of the weather strake. The heads measure approximately 14.5 cm high, 13.3 cm wide at bottom, 7.5 cm wide at top, and 11 cm thick. Each has a 7.0-7.5 cm square mortise carved into one side and bottom to fit a tenon from either end of the crosspiece. Both heads have suffered some damage and been subjected to modern restoration. In one of the museum's storage magazines is a

¹³⁰ Reisner 1913, 84, footnote 1.

box that contains four more Horus-head carvings from the de Morgan boat.¹³¹ The total number of carvings found on this boat, therefore, is six—one on top of each quarter rudder, one on top of each stanchion, and one on each end of the crosspiece. There may be additional Horus-head carvings that went on the ends of an upper crosspiece, but this is currently unconfirmed.



Figure 31. A Horus-head carving mounted on the starboard side of the quarter rudder crosspiece (P. Creasman).

The Horus-head carvings are reported to have had blue-painted wigs, yellow faces, and green eyes,¹³² but of those on display no color remains. The heads in storage are in better condition and display enough pigment to confirm de Morgan's report.

¹³¹ Personal communication Waheed Edwar, 15 May 2005.

¹³² de Morgan 1895, pl. XXXI; see also Reisner 1913, 84.

Although the dimensions of the crosspiece were recorded they are not presented here because it is almost certainly a 19th century reconstruction. The original crosspiece would have needed to be at least 1.5 m long and square in section, measuring somewhere between the size of the socket in the Horus-heads, 7 cm square, and the diameter of the stanchions, approximately 12 cm. If a second or upper crosspiece existed it would likely have had similar measurements to the first, due to the high degree of symmetry exhibited throughout the boat.

Small, semi-cylindrical rails are treenailed to the top of strake 3 at the bow and stern: one in each quarter. The rails are 70-85 cm in length, 5 cm wide at bottom, 3.5 cm wide on top, and 4 cm high. The two at the bow are secured by two treenails each and those at the stern use four. The rails fill the area between the end of the weather strakes and the beginning of the finials, assuming they were present.

Surface Decoration

The boat currently exhibits almost none of its originally fine-painted characteristics. In classic form it would have included colored stripes along the sheer, a solid white deck, and a characteristically Egyptian symbol known as an *udjat* at the bow.¹³³ Using a primer coat was common in ancient Egypt and is the only remnant of paint decoration that is present in quantifiable amounts on the hull. White stains at the stern appear to be from primer, but may be faded white paint. Some patches of "oxidized green" pigment are still present over the white primer.¹³⁴ A plaster substance,

¹³³ Ibid; see also Glanville 1972, many plates; Göttlicher and Werner 1971, pl. xliii; The *udjat*, or sacred eye, is usually found in pairs and is associated with protective power of the gods Horus, Netjer, or Sekhmet.

¹³⁴ "Oxidized green" refers to the color frequently associated with Egyptian vessels; see also Figure 3.

largely assumed to be primer¹³⁵ is found sporadically in small chunks inside mortises and in cracks throughout the hull. The highest frequency of the plaster substance is found in holes in the central strake and in ancient mortises on top of the weather strake. Conventional black-lights and higher powered ultra-violet lamps were cast over all surfaces but yielded no additional paintwork.

The quarter rudder stored on deck exhibits the best surviving example of decoration for either Cairo boat.¹³⁶ De Morgan's drawing of a quarter rudder revealed a well-preserved, or restored, artifact that in 110 years has suffered significantly more damage than was caused by nearly 4,000 years of burial in the desert sands; partially due to deterioration and partially to human agency.

For some time the Dahshur boats were unofficially interactive artifacts while on display. The result of frequent touching can best be seen on the quarter rudder that rests on deck of the de Morgan boat. The paint has been rubbed off up to a distinct line that corresponds to the maximum reach of curious tourists (Figure 29). In large part this phenomena has subsided but tour guides are still left uninhibited in their touching, tugging, and outright grappling with the hulls.

¹³⁵ See Lucas and Harris (1999, 338-66) for a discussion of the use of plaster, primer, and paints in ancient Egypt.

¹³⁶ See Figure 21.

EGYPTIAN MUSEUM, CAIRO GC 4926

The boat labeled GC 4926 by Reisner is an enigma among the extant Dahshur hulls; it is the most complete and yet, it is by far in the worst condition.¹³⁷ The general lack of interest in studying GC 4926 over the years is certainly due to its rather poor state of preservation—yielding much less detailed evidence of its construction and purpose.¹³⁸ Since its excavation, there have been at least two attempts to draft a set of lines for this vessel but both are wrought with glaring errors.¹³⁹

This boat is one of the two that de Morgan sent directly to the Gizeh Museum, as it has been in the constant possession of the Egyptian antiquities authorities since its arrival in late 1894 or early 1895.¹⁴⁰ While the boat is on record as coming from the first cache of vessels excavated in 1894 by de Morgan, its condition has led some in Egypt to suggest that it may have come from the second cache excavated some time after de Morgan wrote his report but before 1902,¹⁴¹ when one of the Dahshur hulls was shipped to Pittsburgh. Salim Hassan's description of the conditions in which de Morgan found the two caches at Dahshur fueled an interesting suggestion:

[The first cache of three] boats were buried in a tunnel-like construction of bricks, and were orientated east-west. About 100 m. to the south of them, [de Morgan] located three more boats of a similar size. These vessels [have] been

¹³⁷ Complete recording and drawing of this vessel even eluded the thorough work of Reisner.

¹³⁸ This vessel was probably in poor condition from the beginning. Frothingham's (1895, 72-3) notes on the arrival of the boats in Cairo had already noted that "one is considerably better preserved than the other."

¹³⁹ One work from 1906 by a "New York yachtsman" found in *Wassersport* (1906, 6-7), was adapted by Haldane (1984, fig. 43), but this uses inaccurate measurements for length and beam. Another work by Jarrett Bell (1933, fig. 1), illustrates an unlabeled Dahshur boat. Bell's drawing shows 11 throughbeams with the quarter rudder stanchions passing through the aft-most one. Of the known hulls only GC 4926 displays these features.

¹⁴⁰ See the beginning of the section on the de Morgan boat for more detail about the origin of the Cairo Dahshur boats.

¹⁴¹ The first vessels excavated by de Morgan were protected by mastabas while those to the south were not.

placed upon the gravel, their sides supported by piers of mud-bricks, and the whole buried under a mound of sand and debris.¹⁴²

It was suggested to me that GC 4926 was the boat removed by Emil Brugsch, circa 1901, and that he sent a better preserved specimen from the Cairo Museum to Pittsburgh; I find this extremely unlikely. While the logic is plausible, in 1901 the Egyptian Museum was under the watch of one of the most prestigious Egyptologists, Gaston Maspero, and removing any artifact, much less a 10 meter-long boat would have proved quite difficult. An equally plausible explanation for the poor state of GC 4926 is that the mud-brick mastaba inside which it was stored collapsed sometime during its 4,000-year history, causing such damage.¹⁴³ Any number of other scenarios could account for its significantly poorer condition than the other vessels, even as early as 1894.

It is tempting to label this boat as the "red" boat sent by de Morgan to Cairo as a significant amount of red paint or red ochre still remains on the inboard face of the weather strakes, but this should be done with caution. The paint that remains on the vessel today is only a trace of the original work that covered the entire boat. To add to the confusion, Reisner also found significant amounts of yellow paint on the exterior.¹⁴⁴ The iconography of Middle Kingdom boats has few primarily yellow hulls as Reisner suggests, but in the dozens of Middle Kingdom boat models the frequency of yellow hulls is significantly greater. When the numerous boat models from the period are considered an obvious trend is apparent for ceremonial craft (Figure 32): weather strakes

¹⁴² 1946, 157.

¹⁴³ de Morgan 1895, 83-4; see also Appendix B.

¹⁴⁴ 1913, 87.

and throughbeams were painted red, and ceremonial hulls similar in shape and design to those from Dahshur, are painted green.¹⁴⁵



Figure 32. Collection of late 12th-and-13th Dynasty boat models in the Egyptian Museum (P. Creasman).

When comparing the two Cairo hulls alone, it is safe to call GC 4926 the "red" boat, as in its original state it would have had much more visible red paint on it because the throughbeams are exposed while on the de Morgan boat's throughbeams are covered by deck planking.¹⁴⁶ Moreover, there is no indication from any source that red faux throughbeams were painted on the deck of de Morgan boat and that its deck planking was painted white.¹⁴⁷ This is, therefore, the most likely scenario for the note in de Morgan's report stating he sent one red and one white boat to Cairo. With GC 4926 labeled as the "red" boat, this confirms Reisner's records while satisfying concerns and questions regarding hull decoration expressed by several scholars, notably Haldane.¹⁴⁸

¹⁴⁵ See Landström 1961, 90-3, figs. 273-93 ; see also Winlock 1955, 45-69; Reisner 1913, many references.

¹⁴⁶ Reisner (1913, 87) notes that the throughbeams of GC 4926 had traces of red paint.

¹⁴⁷ Reisner 1913, 84.

¹⁴⁸ Reisner, 1913, 84-6; Haldane 1984, 80.



Fouilles au sud-ouest. Une barque. — 5 Juin.

Figure 33. A second boat from Dahshur excavations (from de Morgan 1895, pl. XXX).

It is probable that GC 4926, de Morgan's "red" boat, is the same as found in plate XXX of his excavation report. Examination of an enlarged, well preserved master print of the image reveals a maximum of 11 throughbeams. In the extant boats only those in the Cairo Museum have 11 throughbeams. Since the other Cairo boat has been identified above in this thesis as that depicted in plate XXIX, it is reasonable to assume that plate XXX depicts GC 4926. While it is possible that plate XXX shows the missing fifth vessel, it is more likely that an artifact de Morgan himself photographed and published would have been sent to Cairo (Figure 33).¹⁴⁹

¹⁴⁹ I randomly checked 20 of the artifacts recorded in de Morgan's excavation report to see if they were sent to the Egyptian Museum. Without exception each artifact had, at sometime, been stored or placed on

Accordingly, GC 4926 was excavated on or about 5 June, 1894 as indicated by the caption in plate XXX, and measures 9.95 m long, 2.13 m wide, and 0.64 m deep (Figure 34). Within six months of excavation the boat found its way to Cairo, along with the de Morgan boat as discussed above.

The boat is constructed of thick timbers whose sided dimensions increase slightly with hull depth.¹⁵⁰ The central strake is flush with the inboard and outboard surfaces of the hull and serves as the foundation for the rest of the strakes. The central strake is in such poor condition that 80 percent of the entire length from bow to stern is sandwiched between and screwed to modern planks, to preserve what little remains of its integrity.

Five strakes are built up on each side of the central strake, with eleven throughbeams resting in notches cut out on the top of the third or fourth strake on either side. Fitting was performed on the bottom of the fifth strake in three instances to make the beams sit level. The entire deck is well preserved and all deck planks span only one room, fitting in ledges between two throughbeams. The undersides of all deck planks are shaped to rest evenly in the ledges; deck planks in rooms A and B appear to have been treenailed to strakes 3, 4, and the throughbeams in antiquity, although no pegs have survived to confirm this. Peg holes near the outboard edges of the outermost deck planks in each room align with peg holes in the top of strakes 3, 4, and, 5, indicating that they were secured to the hull. It is possible that deck planks were joined to one another by mortise-and-tenon joints but too many planks are out of order to make definitive matches; these mortise-and-tenon joints may be from the planks previous use. The deck

display in Cairo. Some of the artifacts have been transferred or lost since their exhibition, but each was originally sent to the museum.

¹⁵⁰ No samples have been taken to properly identify the wood used in this vessel. It is most likely that the vessel is constructed of cedar, as is the case with the Chicago and Pittsburgh boats (Ward 2000, 84).

planks in rooms A and B are in their original positions, however, their mortises do not align from one plank to the next with enough consistency to conclude that the mortises were intended to join adjacent planks.



Figure 34. GC 4926 on display (J. Levin).

All timbers in the hull exhibit evidence of frequent mortise-and-tenon joinery that provides longitudinal strength and rigidity. Dovetail joinery is present on the inboard surface of the hull but is sparse. Unfortunately, the deck planking could not be completely removed due to concerns about its fragility, thus a conclusive plan and count of dovetails could not be made. Evidence of lashing is restricted to the wash strake and the extreme bow and stern areas.

The two associated quarter rudders are in better condition than the majority of the hull and are stored beside the boat under a canvas. The pair of quarter rudders is matched by a pair of tillers. A pair of quarter rudder stanchions passes through throughbeam 11, and rest in sockets in strake 3 below. Some assembly and a series of repairs were conducted on the quarter rudders in 1999 during restorations by the Carlos Museum and later continued by the Egyptian Museum restorers. Paired short semi-cylindrical rails at the bow which, were originally secured by treenails, have recently been removed from the hull.

The hull is in very poor condition but yet has preserved its basic shape.¹⁵¹ Although the outer surface has suffered extensive damage from wear, erosion, and fungal deterioration, the interior has fared much better. Lower strakes are significantly more deteriorated and have been subjected to several modern repairs and repair attempts. The central strake and the stern section have suffered the greatest damage, with the central strake missing at least a 10 cm portion at the bow and at least twice that at the stern. A significant portion of the stern-port quarter is also missing (Figure 35).

Daily, the boat is exposed to the hands of curious tourists and excited tour guides, although in the last year enforcement of the hands-off policy has become much better. It is unprotected against fluctuations in humidity and is positioned directly over two air-conditioning ducts in the floor that remain on 24 hours a day.

¹⁵¹ The hull has probably been in poor condition since, or even before, excavation as reflected by early reports; see *supra*, n. 138.

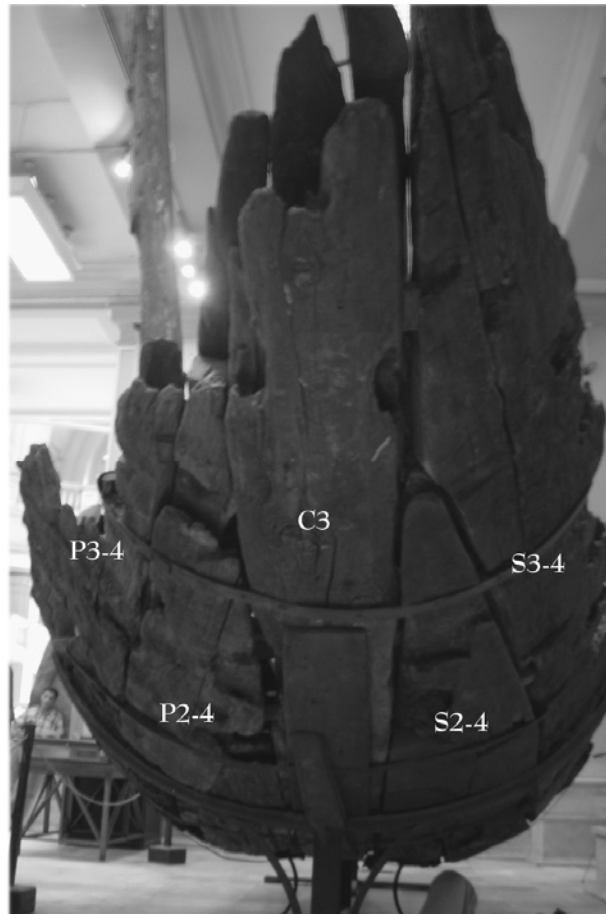

Figure 35. Stern of GC 4926, from below (P. Creasman).

Most original tenons were removed and an undetermined number were replaced with modern ones sometime after excavation. When exactly this process began is unknown but it continues today. Fashioning crude mortises for modern replacement tenons, as was done on the de Morgan boat, however, is uncommon. Between the numerous excess mortises from previous ancient uses of the planking and the generally bad condition of the hull, addition of modern mortises was largely unnecessary.¹⁵²

Several original tenon fragments remain lodged in the mortises but analysis for most

¹⁵² Supra, n. 90; Cutting new mortises can only be confirmed in two occasions on GC 4926. It seems that whoever replaced the ancient tenons hammered them into place, as revealed by clearly visible hammerhead impressions, and likely picked a mortise without a corresponding match on the adjacent plank. Instead of cutting the excess portion of the tenon and starting over with another mortise, new mortises were cut into the adjacent plank to receive the tenon. This process would have been time consuming.

would have required disassembly of the hull, a procedure that was not permitted under the condition of our study. Several tenons pre-dating the boat's construction remain in their original mortises.

Parts of at least six original throughbeams remain all of which are supported on top of thin modern planks due to their fragmented and fragile condition; all the other throughbeams are modern replacements. Most throughbeams are fitted to their corresponding sockets in strakes 3 and 4, but in three occasions the socket was expanded to fit the new throughbeams. Iron bands have been secured with screws and metal nails around the hull at each throughbeam, except where three floor supports contact the boat. The iron bands and fasteners have leached some oxides into the wood but recent restoration efforts, short of removing the bands, have corrected most of this problem. There is no evidence for the original use of metal as structural components in the hull. Small holes in the hull planking above and below the waterline are patched by treenails or plaster.

Since excavation, the desiccated boat has been bearing the brunt of its own weight. The iron bands may have helped at first but are now compounding the problem and causing the boat to distort dramatically. Thus, hull planks now have gaps up to 15 cm wide, and extensive modern repairs have been conducted since the early 20th century to rectify this problem. It is unlikely that the boat could withstand a move to the Egyptian Museum under construction at Giza unless it is first disassembled, packaged properly, and transported piece by piece.

The information provided in the following description of the boat and its associated components was collected during the same field sessions as mentioned in the

Introduction. Hand-drawn lines were drafted from offsets on both sides of the hull at throughbeams and other critical locations, while three-dimensional reconstructions were constructed from at least 20 sections made at predetermined intervals, usually half a meter apart. The description below follows the format of the de Morgan boat.

Dating

To date, no samples have been taken from the timbers for analysis by radiocarbon (¹⁴C) or any other method. It is likely that ¹⁴C testing of this boat would yield dates in the range of 1990-1900 B.C., and be nearly identical to that of the de Morgan boat. Since evidence of timber reuse is common throughout the boat, their felling dates should predate the death of Senwosret III (c. 1831 B.C.) by a certain length of time.

Most ancient planks in the hull have many extra, unmated mortises, and combined with the poor condition of the wood, it is not at all surprising that the boat has gone largely overlooked. Most excess mortises without a corresponding mate pre-date the use of the timbers for their current application.

Central Strake

The central strake appears to consist of three planks butt jointed to one another. The strake is in such poor condition, and since it is almost entirely fitted between modern boards for support, it is difficult to say with certainty that there are only three planks. There is a remote possibility that plank C3 consisted of two distinct planks, but if it were so then the scarf between C3 and proposed C4 would align laterally with the joints of planks of port and starboard 1-3 and 2-4. Not only would such a line of scarfs

weaken the vessel significantly, but it is also unprecedented on the other Dahshur hulls, since effort was expended on the part of the builder to specifically avoid such placement of joints. There is no evidence of convex and concave shaping at butt joints, nor is there evidence for mortises placed centrally across butt joints. Large lateral and longitudinal cracks are prevalent in each plank. The central strake is flush with the inboard and outboard surfaces of the hull, but the sandwich boards are not (Figure 36).

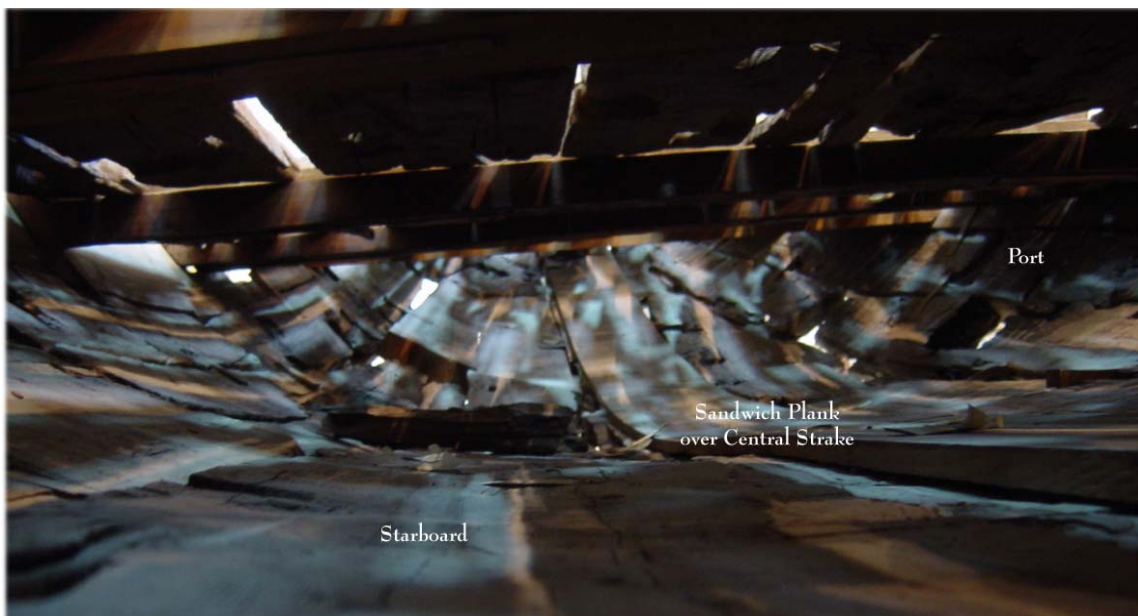

Figure 36. Sandwich plank over the central strake of GC 4926, interior (P. Creasman).

Plank widths are fuller toward midships and taper by up to 8 cm at the bow and stern. Based on measurements from the intact part of the central strake which is generally limited to above the waterline, plank thicknesses are more consistent throughout, with very little tapering apparent. This is the thickest strake in the hull and its principal dimensions are given in Table 7.¹⁵³

¹⁵³ Thickness was measured as the distance between the sandwiching boards when a reliable section of the central strake was not available.

Table 7. Central stake dimensions in meters - GC 4926.

Plank	Length	Fwd. Width	Aft Width	Thickness (fore/aft)
C1	2.83	0.20	0.26	0.08 / 0.095
C2	4.23	0.26	0.22	0.095 / 0.095
C3	2.81	0.25	0.23	0.09 / 0.085

On the interior, at least 10 dovetails are arranged laterally to secure the central stake to the adjacent planks but the sandwich board obscures any reliable count or examination. Frequent deep mortises, measuring approximately 14 cm deep, 7.5 cm wide, and 1.7 cm thick, are arranged in a plane near the middle of the planks' thickness in what appears to be a regular interval of 43-45 cm. Notably many mortises from the plank's previous use prohibited a uniform pattern of joints from being followed, but breakage and damage to the planks prevents the determination of an such pattern. Mortises without a corresponding mate on an adjacent plank have been excluded from such an evaluation as they are from a previous use of the timber. Stacking of two or three mortises directly over one another is common in the central stake and throughout the hull: no more than three stacked mortises are found on the central stake but four have been observed at least on one stroke (i.e., S5-3) (Figure 37).

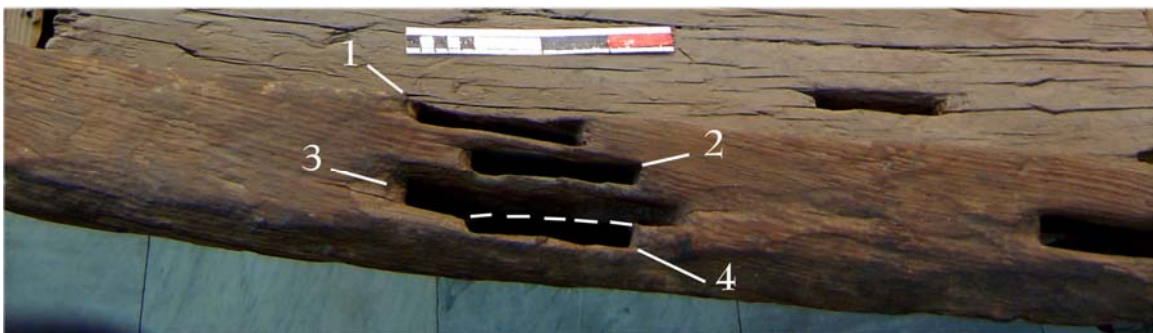

Figure 37. Mortises stacked four deep on S5-3 (P. Creasman).

Half-mortises situated roughly in the middle of each plank's thickness are present at each corner of the planks where butt joints occur. The half-mortises measure 4-6 cm deep, 4 cm wide, and 1.8 cm thick. None of these retain any evidence of tenons, nor do they exhibit significant signs of wear, such as dulling of the edges. On only one occasion did an adjacent plank outboard of the half-mortises contain a corresponding mortise, but this also may have been from a previous use of the timber.

One small square recess is visible underneath the sandwich boards. The recess measures about 2 cm square and is less than 0.5 cm deep. More square recesses are expected centered under where throughbeams 4-9 cross the central strake, but this cannot be confirmed.

Planks C1 and C3 are beveled on both sides of their outboard surface, creating a flat bottom approximately 15 cm wide running the length of the boat. The bevel is significantly more prominent on C1 than C3, where it is barely noticeable owing to fuller sections aft of midships. If a cross section of the planks is represented by a trapezoid, then the beveling would best be understood as a removal of both of the lower corners (Figure 38).

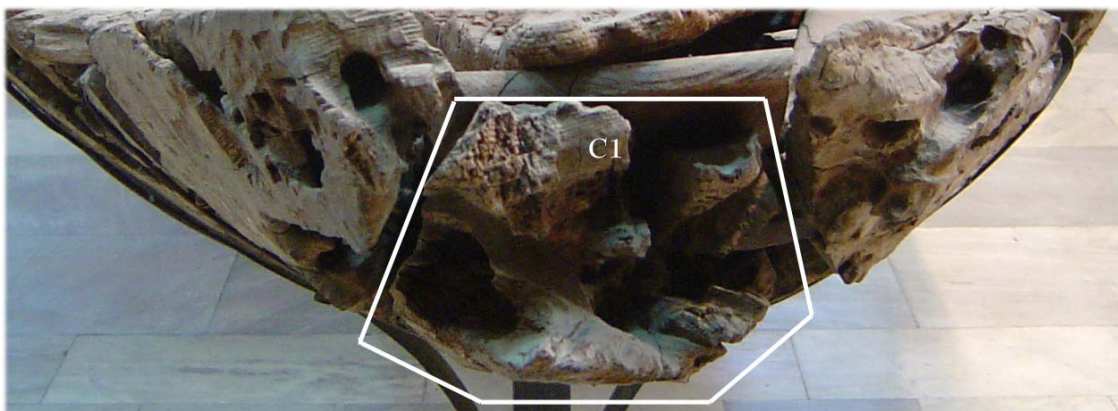

Figure 38. Outboard beveling on the central strake, at the bow (P. Creasman).

Hull Planking

The hull consists of eleven strakes—a central strake and five strakes each to port and starboard. The central strake and strake 1 originally each consisted of three planks per side. Strake 2 was likely made up of four planks per side, although damage and repairs over time have changed this configuration on the starboard side. Strake 3 originally consisted of five planks per side, but damage and repairs have taken their toll here as well. Damage to strake 4 makes it difficult to configure its original components on both port and starboard, but the starboard strake was made up of three planks, as on the de Morgan boat. Port strake 4 is made almost entirely of modern replacements and probably consisted of only two planks, instead of the usual three. Strake 5 consists of four planks on either side, although their precise scarfings are difficult to discern in some areas.

All of the planks whose ends were visible revealed that they were hewn from heartwood, or from wood very close to the core of a tree. Each plank was hewn relatively parallel to the grain with the sides of the plank beveled to provide angled seams with the adjacent planks; these angled cuts are nearly equal.¹⁵⁴ Each of the 40 or more planks that comprised the hull was smoothly finished on the inboard face, as was probably the case for the outboard. The degraded conditions of most of the outboard faces, particularly below the waterline, do not permit for a comprehensive study. In describing the strakes, 1, 2, and 3 can be considered in a similar context, but the design and purpose of strakes 4 and 5 would better be discussed independently of the others.

¹⁵⁴ *Supra*, n.105.

The individual planks in strakes 1, 2, and 3 range in length from 1.3-2.7 m, with most about 2 meters long. A maximum width of 36 cm is found near throughbeams 7 and 8, with several planks in strake 2 narrowing to a point. Thickness in each strake tapers by about 0.5 cm, toward the outboard side. This trend is consistent throughout the port and starboard sides of the hull, with 10 cm as the maximum thickness on the central strake. The sides of the central strake measure 9.5 cm and each subsequent strake reduces in thickness on its outboard side by about 0.5 cm up to strake 4, which measures 8.0-8.5 cm thick. Thickness in the weather strake is the least consistent and varies from 7.0-8.0 cm. For ship lines, construction plans, and flattened planking plans see figures 39, 40, and 41, respectively.

Half-mortises situated roughly in the middle of a plank's thickness are present at all but one extant corner of an ancient plank where butt joints occur; they occur exclusively on the plank's upper sides. The half-mortises measure 4-6 cm deep, 4 cm wide and 1.8 cm thick. None of these retained any evidence of tenons, nor did they exhibit significant signs of wear.

The butt joints of each strake are approximately parallel with those of the same strake on the opposite side. Adjacent strakes do not have joints in line with one another. The planks above and below each butt joint exhibit their maximum widths at these locations, giving the hull planking an elongated honeycomb-like construction. The narrowest place on each plank is at its ends, or where a plank terminates its run into the center strake.

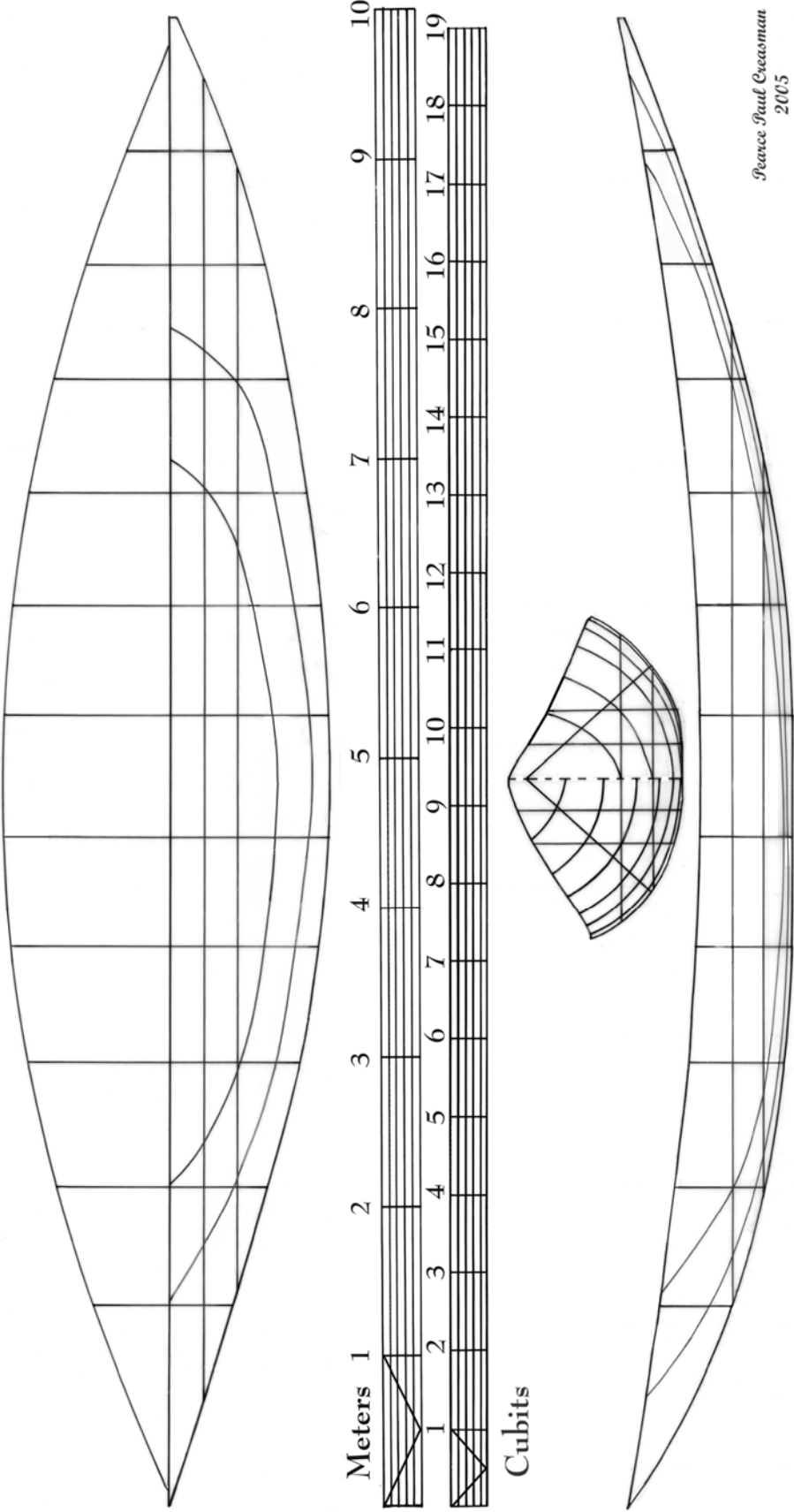

Peavee Paul Creasman
2005

Figure 39. Hull lines for GC 4926.

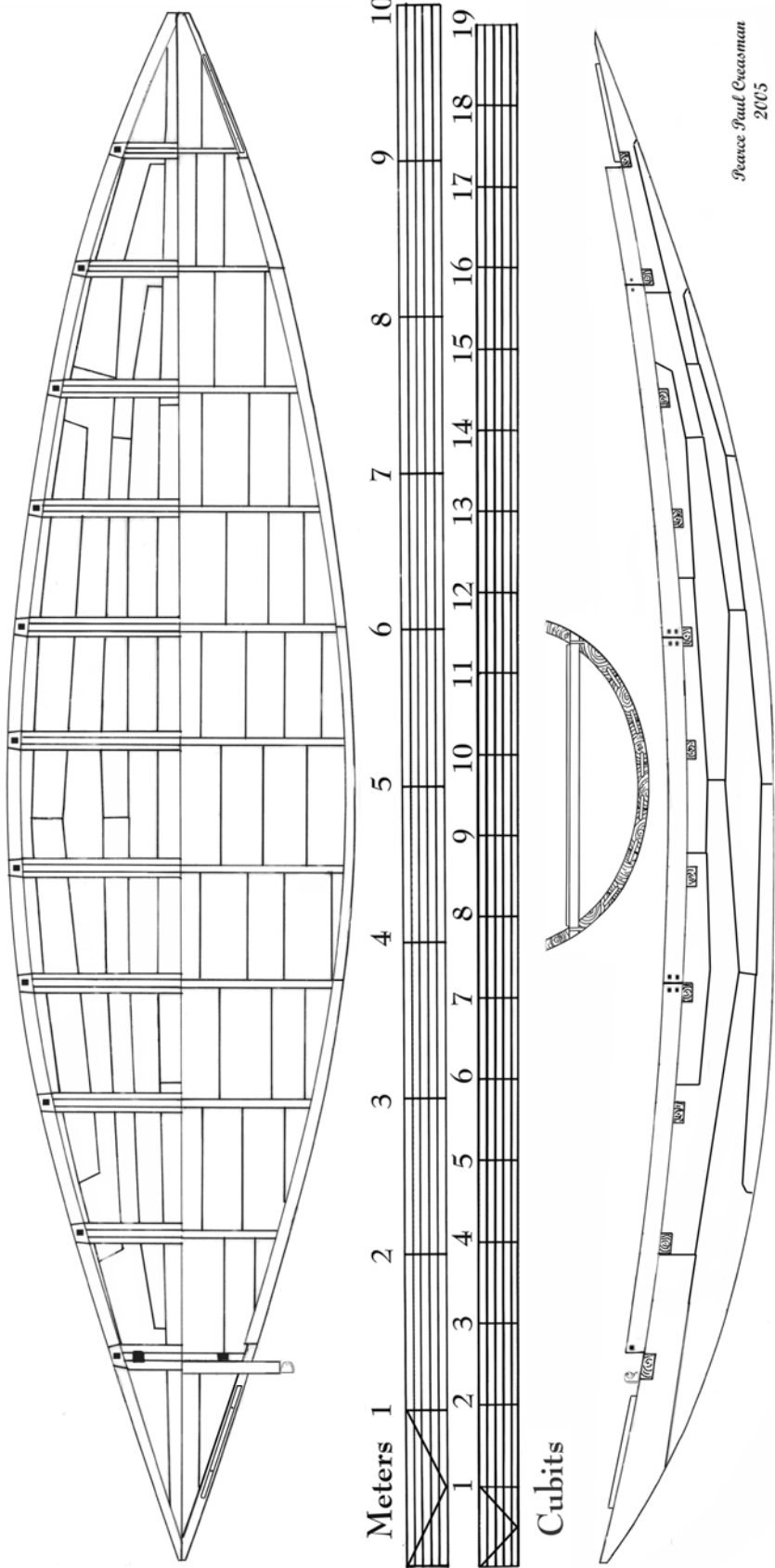

Figure 40. Construction plans for GC 4926.

Peavee Paul Crossman
2005

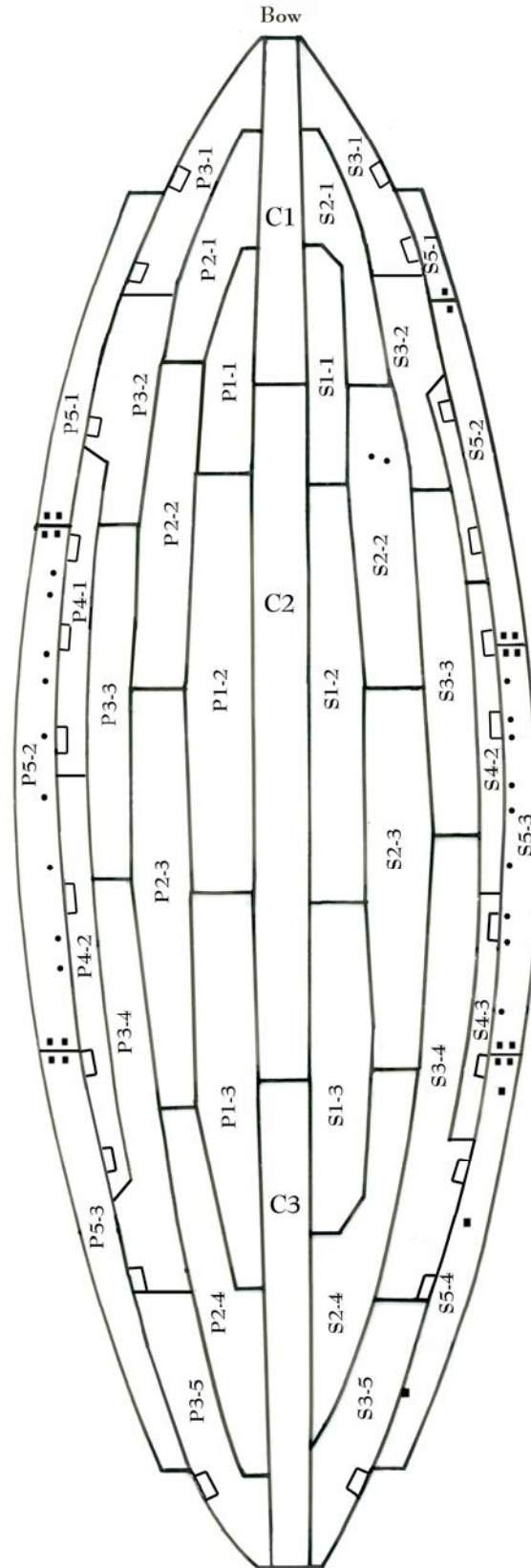

Figure 41. Flattened planking plan of GC 4926 - not to scale (P. Creasman).

Table 8 lists principal measurement of each plank in strakes 1, 2, and 3. Due to heavy degradation and reconstructions, length measurements have been taken to represent the original distance as close as possible. Plank S2-2 has two treenail holes, measuring 0.7 cm in diameter, with ancient treenails near the bow on the outboard edge; both holes are below the waterline. Planks S2-3/S2-4 appear to be a single plank with a repair, but originally would have been two separate planks of similar measurements¹⁵⁵ and with the same joint placement as in P2-3 and P2-4.¹⁵⁶ Few planks have escaped modern patching; planks S1-3 and S2-3 are primarily modern replacements.

Table 8. Dimensions of strakes 1, 2, and 3 in meters - GC 4926.

<u>Plank</u>	<u>Length</u>	<u>Fwd. Width</u>	<u>Aft Width</u>	<u>Thickness (Inboard/Outboard)</u>
P1-1	2.15	0.15	0.29	0.095 / 0.09
P1-2	2.69	0.30	0.30	0.095 / 0.09
P1-3	1.82	0.30	0.10	0.095 / 0.09
P2-1	1.94	0.08	0.21	0.09 / 0.085
P2-2	2.46	0.23	0.30	0.09 / 0.085
P2-3	2.34	0.30	0.26	0.09 / 0.085
P2-4	2.32	0.24	0.05	0.09 / 0.085
P3-1	1.70	0.00	0.15	0.085 / 0.08
P3-2	2.15	0.24	0.19	0.085 / 0.08
P3-3	2.25	0.20	0.17	0.085 / 0.08
P3-4	1.87	0.17	0.26	0.085 / 0.08
P3-5	1.37	0.20	0.10	0.085 / 0.08
S1-1	1.82	0.10	0.32	0.095 / 0.09
S1-2	2.70	0.30	0.00	0.095 / 0.09
S1-3	1.83	0.21	0.06	0.095 / 0.09
S2-1	1.87	0.09	0.27	0.09 / 0.085
S2-2	2.22	0.21	0.29	0.09 / 0.085

¹⁵⁵ Measurements for length were taken at the forward butt joint of the main patch but the actual joint would have been slightly farther aft.

¹⁵⁶ Previous restorations (in 1999?) incorrectly adhered an original piece of timber from somewhere on the hull across the butt joint of P2-3 and P2-4. The result presents two incorrect concepts: 1- that this was an ancient repair, 2- these two planks were originally one.

Table 8 continued

<u>Plank</u>	<u>Length</u>	<u>Fwd. Width</u>	<u>Aft Width</u>	<u>Thickness (Inboard/Outboard)</u>
S2-3	2.14	0.30	0.28	0.09 / 0.085
S2-4	2.20	0.26	0.00	0.09 / 0.085
S3-1	1.86	0.00	0.19	0.085 / 0.08
S3-2	2.20	0.16	0.20	0.085 / 0.08
S3-3	2.13	0.21	0.16	0.085 / 0.08
S3-4	1.85	0.18	0.34	0.085 / 0.08
S3-5	2.06	0.31	0.00	0.085 / 0.08

Apart from strake 5, strake 4 is the only strake in the hull that does not terminate its run at the central strake. Little remains of this strake on either side of the vessel and modern replacement pieces occupy its place. While this strake follows the same trends of fitting and narrowing, these are less pronounced, especially on the strake's upper edge. The port strake is significantly shorter than the corresponding strake on the starboard, and is only assumed to have it originally consisted of two planks. Based on modern reconstructions and size of the strake cavity, a third plank would have been unnecessary. However, surviving evidence is not sufficient to confirm the original configuration of the entire strake.

Table 9 lists principal measurements of each plank in strake 4. Planks P4-1 and P4-2 are modern replacements and S4-3 has significant modern repair work.

Table 9. Dimensions of strake 4 in meters - GC 4926.

<u>Plank</u>	<u>Length</u>	<u>Fwd. Width</u>	<u>Aft Width</u>	<u>Thickness (Inboard/Outboard)</u>
P4-1	1.94	0.00	0.17	0.08 / 0.075
P4-2	2.47	0.16	0.00	0.08 / 0.075
S4-1	1.56	0.09	0.11	0.08 / 0.075
S4-2	1.73	0.13	0.15	0.08 / 0.075
S4-3	2.05	0.14	0.15	0.08 / 0.075

Strake 5 encloses the deck area between throughbeams 2 and 11, and rests on top of the throughbeams. Like the weather strake on the de Morgan boat, strake 5 on this vessel is more aptly termed a weather strake. The weather strake's structural importance is debatable. An end-piece of the weather strake is stored in the hull below the deck planks, and was probably from a small fourth plank that fit in between P5-2 and P5-3 or P5-1 and P5-2. It is possible that the weather strakes were asymmetrical in their configuration, like strake 4, with only three planks on the port and four on the starboard side, but this seems unlikely. If so, then the extra weather strake end-piece would have to have been attached to the aft end of S5-4, although it does not appear to fit there.

Planks S5-3 and P5-2 are unique for the pair of boats in Cairo; each has nine peg holes approximately 0.8 cm in diameter lining the lower portion of the timber (Figure 42). Six of the holes on the starboard side retain their original pegs and all empty holes would have been fitted with plugs of some sort.¹⁵⁷ Visual examination of the wood grain on these two planks suggests that both were cut from the same tree. No combination of overlapping or rotating aligns the two planks with more than five of the holes. These are the only planks on either Cairo boat that do not have unmated mortises on their upper and lower surfaces. Neither plank has any mortise on their upper face. Had it not been for the peg holes, these two timbers would appear to have been fashioned new for use on this boat. If so, they could be expected to yield an accurate date if carbon dated.



Figure 42. Inboard surface of S5-3 and its joint with S5-4 (P. Creasman).

¹⁵⁷ The starboard side of the vessel is not accessible to tourists. The port side pegs were probably taken as souvenirs long ago.

Signs of timber re-use in ancient times are present on the inboard face of the weather strake, specifically on S5-4 (Figure 42). Three small square recessed holes, of the same type as those previously associated with the central strake, are present on this plank. They are roughly 2 cm square, and spaced approximately 65 cm apart, which is similar to the size and spacing of the square recesses on the de Morgan boat.

The weather strake is attached to the rest of the boat by two fastening methods: lashings and mortise-and-tenons. As the mortise-and-tenon joints are frequent throughout the hull, they will be discussed below with fastenings. Here, it should be noted that the mortises on top of S5-1 and S5-4 on the starboard side still retain traces of plaster filling. No evidence of the lashing, rope, or other fiber exists in any of the lashing holes.

The lashings on the weather strake are intended to secure planks within the same strake. Between the planks that comprise the weather strake, the lashings overlapped the butt joints, adding considerable strength to the joints. The lashings rested in recessed grooves 2.0 cm by 2.0 cm, and 1.7-2.0 cm deep, on both the inboard and outboard face of the planks. They consist of only one hole at the joints of S5-1 to S5-2 and S5-1, S5-4, P5-1, P5-3 to the hull, and double holes at S5-2 to S5-3, S5-3 to S5-4, P5-1 to P5-2, and also at P5-2 to P5-3 (Figure 43). All of the recessed grooves are parallel to the central strake except for the outboard grooves of double lashing holes, which are perpendicular to those on the interior. The fore-and-aft most ends the weather strake, as a single unit, were lashed to the main hull but how this was done has yet to be determined. Table 10 lists principle measurement of each weather strake plank.

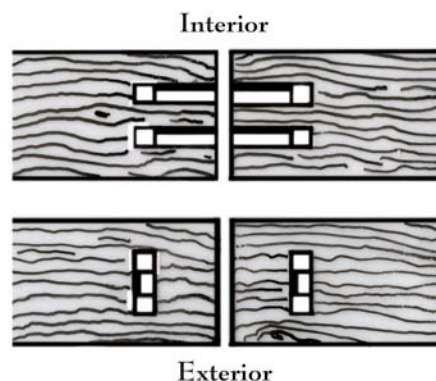

Figure 43. Detail of double lashings on the weather strakes (after Landström 1970, figs. 277 and 278).

Table 10. Dimensions of strake 5 (weather strake) in meters - GC 4926.

Plank	Length	Fwd. Width	Aft Width	Thickness (Inboard/Outboard)
P5-1	1.50 ¹⁵⁸	0.00	0.11	0.0.8 - 0.07
P5-2	3.10	0.17	0.17	0.0.8 - 0.07
P5-3	3.35 ¹⁵⁹	0.16	0.14	0.0.8 - 0.07
S5-1	0.51	0.08	0.18	0.0.8 - 0.07
S5-2	2.28	0.12	0.15	0.0.8 - 0.07
S5-3	2.58	0.13	0.17	0.0.8 - 0.07
S5-4	2.15	0.16	0.16	0.0.8 - 0.07

Throughbeams and Deck Planking

Eleven lateral throughbeams stiffen the hull and support the deck planking. Parts of six original throughbeams remain (1, 2, 3, 9, 10, and 11) and are rabbeted to receive deck planking like those on the Chicago and Pittsburgh boats (Figure 44). The ledges of the throughbeam rabbets are beveled slightly upward to receive the chamfered bottoms of the deck planks. The rabbet does not run the entire length of the throughbeam, and is limited to the inboard length of the beam (Figure 45).

¹⁵⁸ Due to degradation and damage a gap is now responsible for approximately 0.45 m of the length that would previously have been a continuous run of timber.

¹⁵⁹ Due to degradation and damage a gap is now responsible for approximately 1.10 m of the length that would previously have been a continuous run of timber.

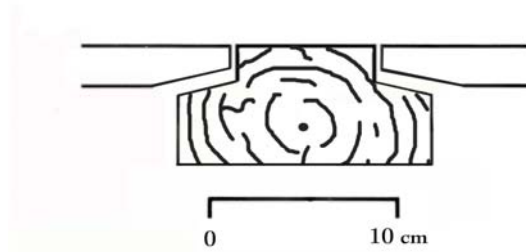

Figure 44. A rabbeted throughbeam with deck planking (P. Creasman).

All throughbeams rest flush in notches cut into strake 3 or 4. Throughbeams 1, 2, 10, and 11 rest in strake 3 while throughbeams 4, 5, 6, 7, and 8 rest in strake 4. Throughbeams 3 and 9 each have one end in strake 3 and the other in strake 4: the starboard end of throughbeam 3 and the port end of throughbeams 9 rest in strake 4.¹⁶⁰ All of the throughbeams except 1 and 11 were originally underneath the weather strake. Shaping was required on the bottom of the fifth strake to make throughbeams 5, 6, and 7 sit level, but it is unclear if this is a modern or ancient adjustment.

The width of each original throughbeam begins to narrow about 10 cm from either end reducing in width by a total of approximately 2 cm at their extremity (Figure 45).¹⁶¹ Throughbeam 11 also exhibits this narrowing at one end but is less pronounced than in the others. Narrowing at the ends is also replicated on modern reconstructed throughbeams. The ends of throughbeams in the bow and stern are cut at an angle consistent with hull curvature so that their ends are flush with the outer surface of the hull. Some throughbeams, particularly those in the bow, protrude slightly beyond the outer surface of the hull, but this is due to hull distortion and would not have been the case when the boat was newly constructed.

¹⁶⁰ Asymmetrical construction is not typical of ancient Egyptian boat construction. This is the only occurrence of this type of throughbeam placement in the Dahshur hulls.

¹⁶¹ See Figure 23.

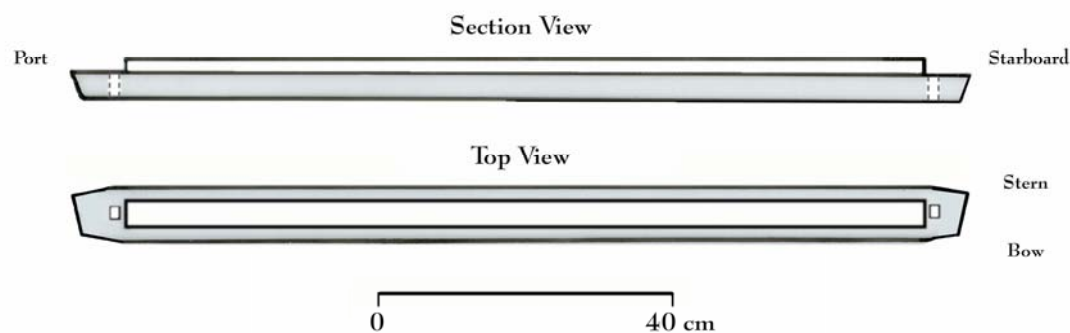

Figure 45. Throughbeam 2 from GC 4926 (P. Creasman).

Each throughbeam is spaced approximately 68 cm apart. Around midships, and in the aft part of the vessel, throughbeams have noticeably greater thicknesses, corresponding to fuller sections aft of midships. Every original throughbeam is cracked at or near its center.

Principal measurements of the throughbeams and rooms between them are listed in Table 11. Where modern replacement throughbeams are present, measurements were taken from the notches in which the originals would have rested and the distance they would have spanned.

Table 11. Dimensions of throughbeams and rooms in meters - GC 4926.

Throughbeam	Length (Fore)	Length (Aft)	Length (Ave)	Width	Height (Thickness)	Increment to Next Face (Room)
TB1	0.78	0.81	0.80	0.10	0.04	From bow to frontTB1 0.84
TB2	1.23	1.26	1.25	0.10	0.04	SternTB1 to BowTB2 0.65
TB3	1.47	1.49	1.48	0.10	0.04	0.67
TB4	1.76	1.79	1.78	0.12	0.045	0.65
TB5	1.98	2.00	1.99	0.11	0.045	0.65
TB6	2.09	2.10	2.10	0.13	0.045	0.62
TB7	2.11	2.10	2.11	0.12	0.04	0.68
TB8	2.00	1.97	1.99	0.12	0.04	0.62
TB9	1.75	1.73	1.74	0.12	0.04	0.64

Table 11 continued

Throughbeam	Length (Fore)	Length (Aft)	Length (Ave)	Width	Height (Thickness)	Increment to Next Face (Room)
TB10	1.44	1.35	1.40	0.13	0.045	0.71
TB11	0.89	0.87	0.88	0.16	0.045	0.65
						Rear TB11 to Stern 1.11

The throughbeams were originally fastened to the strake in which they rest by rectangular treenails approximately 2.5 x 3.0 cm of unknown lengths, but none of the treenails have survived. The treenail holes did not originally penetrate the hull completely, but due to breakage they appear to do so today. Damage and reconstructions, particularly the use of iron bands, obscure or otherwise make it difficult to ascertain if every throughbeam was secured in this manner. There is evidence for the presence of the rectangular treenails on throughbeams 1, 2, 3, 9, 10, and probably also on 11. The throughbeams amidships have not survived, nor has most of the strake to which they were secured to on either side of the hull. No evidence for rectangular treenails is present for throughbeams 4-8, although it is almost certain they occurred originally. Oddly, on the port side of throughbeam 9, there is a circular hole where a rectangular one is expected, having slightly smaller dimensions than the rectangular holes.

Throughbeam 11 stands out from the group in several respects, but primarily in its robustness. It has a greater width than all the others and a much shorter length than all but throughbeam 1. Such a stocky construction confirms what is evident, that this was designed to be by far the strongest throughbeam in the hull and support a heavy load. Here, the quarter rudder stanchions pass through large square holes measuring

approximately 7.5 cm square, about 20 cm in from the ends of the throughbeam (Figure 46).

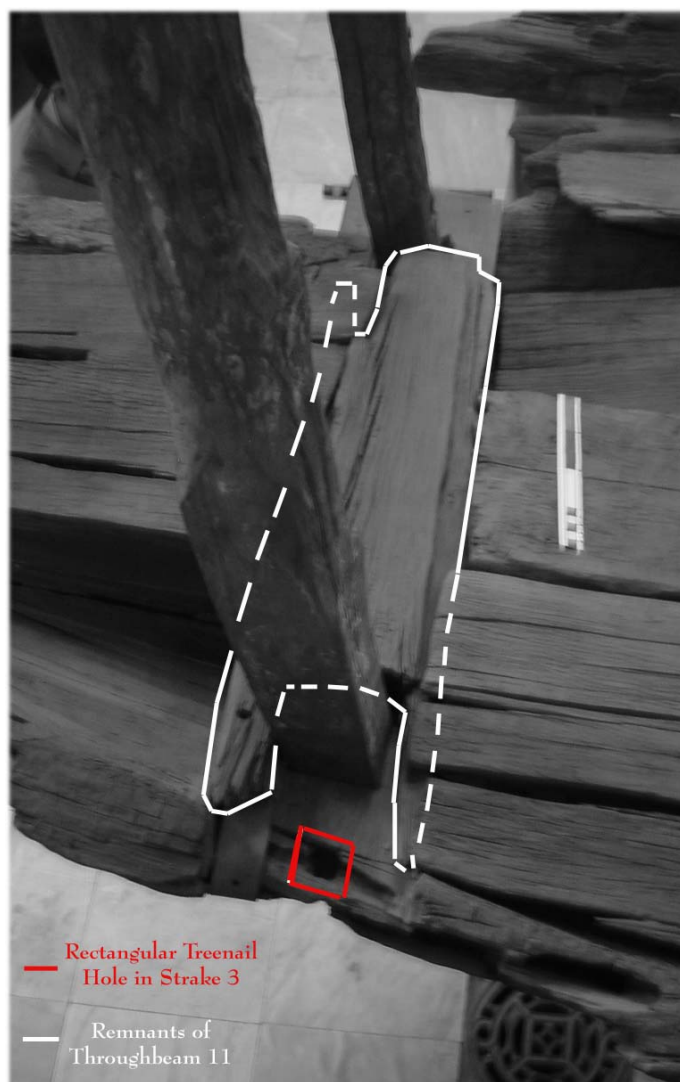

Figure 46. Throughbeam 11 and quarter rudder stanchions on GC 4926, from starboard (P. Creasman).

Deck planking covers all 12 rooms, or 'sections' as labeled by the museum staff,¹⁶² and are beveled on the underside at both ends to rest in the throughbeam rabbets. Additionally, the planks in section 1 (room A) and section 2 (room B) have peg holes

¹⁶² *Supra*, n. 113.

through the planks that align with holes in the throughbeams underneath. No pegs, however, remain and it is not possible to tell when the holes were added.

Seventy-five planks were needed to cover the entire deck area, but originally that number could have varied by approximately ± 10 planks due to breakage and potential confusion of planking between the two Cairo boats.¹⁶³ All planks span only one room. The outermost deck planks bordering the hull are beveled on their outboard edge so that they lie flush with the top of the main hull. All deck planks rest on top of the throughbeams or directly on the hull, as is the case in sections 1 (room A) and section 12 (room L). Sometime since the boat has been in the Cairo Museum, the deck planks have been rearranged in approximately their appropriate positions, only four are noticeably out of place. Distortion and breakage prevent every plank from being placed in its exact original position. Unfortunately, precise placement of many planks cannot be determined, as they are shifted around by the museum staff from time to time, making a distinct labeling system difficult.¹⁶⁴ For the purposes of this study each section was labeled numerically from bow (1) to stern (12), and each plank was lettered from starboard (a...) to port (...z). Each section and plank was photographed and catalogued, as on the de Morgan boat. The principal measurements of each plank can be found in Appendix F.¹⁶⁵

As a whole, the deck planks are in good condition, especially when compared to the remainder of the hull. All planks are finished on the top surface and partially finished on the bottom; many still bear adze and chisel marks on both surfaces. Heavily damaged ancient mortises are rampant on the underside of all planks. Their frequency alone

¹⁶³ Plank "b" in section 10 (room J) does not appear to belong to GC 4926.

¹⁶⁴ The restorers and conservators are hesitant to use any adhesive labeling system.

¹⁶⁵ With approximately 75 planks, the table would be disruptive if placed in the text.

makes it possible for several to align up with those on the adjacent planks. Although a pattern mated mortises can be seen between many of the deck planks, it is likely that the planks in each room were edge joined by mortise-and-tenon joins.¹⁶⁶

Plank lengths range from 0.5 m to 1.0 m depending on their intended positions on the boat. Most planks are approximately 70 cm long and rest snugly between throughbeams. Plank widths vary from 11-34 cm and there appears to be little consistency in their widths. Plank thicknesses, however, are largely consistent and around 3.0-3.5 cm in the middle of the plank decreasing by less than 1 cm toward either beveled end. Significant variation in such thickness in some planks is due to damaged or "exploded" ancient mortises (Figure 47).



Figure 47. Exploded mortises from the underside of a deck plank - GC 4926 (P. Creasman).

Fastening and Joinery

Mortise-and-tenon joints, dovetail fastening, and lashings are present on GC 4926. Mortises 7.3-7.9 cm wide, up to 14 cm deep, and 1.6-2.0 cm thick are cut into the inboard and outboard sides of the hull and deck planking, with the exception of P5-2 and S5-3, as mentioned above.¹⁶⁷ All planks have evidence of frequent mortise-and-tenon edge joinery that makes the hull appear to be of poor craftsmanship. Most mortises are

¹⁶⁶ Reisner 1913, 87.

¹⁶⁷ Half-mortises in butt joints have been recorded above, as well.

from prior use in ancient times, as suggested by the occurrence of unmated mortises and tenons, although both are less frequent on this vessel than in the de Morgan boat.

Evidence of plaster caulking in several mortises indicates that they were plugged.

Inspection of mortises revealed chisel marks of two sizes, one of 0.5 cm wide and the other 1.2 cm wide. Most mortises had nearly flat bottoms and would have been close to rectangular in section. Not all mortises were examined as the hull could not be disassembled, but these measurements are typical as little variation was found.

Occasionally, mortises were slightly wedge-shaped in section but this was uncommon.

At least three mortises under each throughbeam and two in each hull plank were measured, revealing that mortises in the forward half of the vessel are 0.80 cm to 1.50 cm shorter than those amidships and slightly aft. Mortises at the stern of the boat have fuller measurements than those in the bow, but are smaller than those found amidships. They appear to be regularly spaced along plank sides every 60 cm, but the mortises from previous ancient use restricted regular placement and significant variation is present in some areas as a result. All tenons currently holding the boat together are modern replacements and most have a dark brown or black coating. There is no evidence that slips were used to secure the tenons in place.¹⁶⁸

Five of the eight planks at the ends of strakes 2 and 3 terminate in points, of which three have a mortise that secures the strakes through two adjacent planks.¹⁶⁹

Tenons would have fit snugly into the mortises with dimensions equal to or slightly larger than those of the mortises; they were hammered into place. Several ancient tenon fragments are still locked in the planks; none could be readily removed for

¹⁶⁸ *Supra*, n. 120.

¹⁶⁹ See Haldane (1984, 23-6) for further discussion.

inspection. The wood used for ancient tenons is noticeably darker than the wood used in the rest of the boat; the tenons were coated with tar or pitch in antiquity. Evidence of such tarring or pitching is standard on mortises and ancient tenons, as is the occurrence of a grey ash-like substance and dark staining. Ash and staining occur on ancient tenons that are significantly degraded and lodged into place so these substances cannot be a modern addition.

There is one instance of a mortise with peg holes and a pegged modern tenon (Figure 48). The mortise has black staining identical to that found in mortises with ancient tenon fragments, so it is likely that the mortise is also ancient (Figure 48, bottom left); it is not possible, however, to determine if the peg holes are ancient or modern.



Figure 48. An ancient mortise with pegged modern tenon in GC 4926 (P. Creasman).

Dovetail joints cross planking seams laterally with no visible exceptions, but they occur less frequently than on the other Dahshur hulls. A complete recording and analysis of the dovetails could not be made, as access to the interior of the hull was restricted due to concerns over further damage to the artifact. Several accessible dovetails measure 13.0-16.5 cm long, 5.2 cm wide at the ends, which taper to 2.4-3.0 cm narrow at the middle, and 2.0-2.5 cm deep. Dovetails are usually spaced well over a meter apart but some are placed as close as 70 cm.

Each dovetail is custom shaped to fit its socket in the boat with those at the ends being the most drastically angled in wide "V" shapes and their frequency decreases with each strake outward. No dovetails were used to join the weather strake to the hull. All of the dovetails themselves are modern replacements, but the same cannot be said for the sockets in which they rest.

Lashings can be confirmed only on the weather strake. Mortise-like holes on either side of the bow are in line with one another, following the section of the boat, and most likely retained lashings (Figure 49). These holes are smooth on their interior as if they had been chafed by rope and have no signs of tar, ash, or pitch. The stern is almost non-existent where lashings would be expected, and if such evidence existed it is now lost.

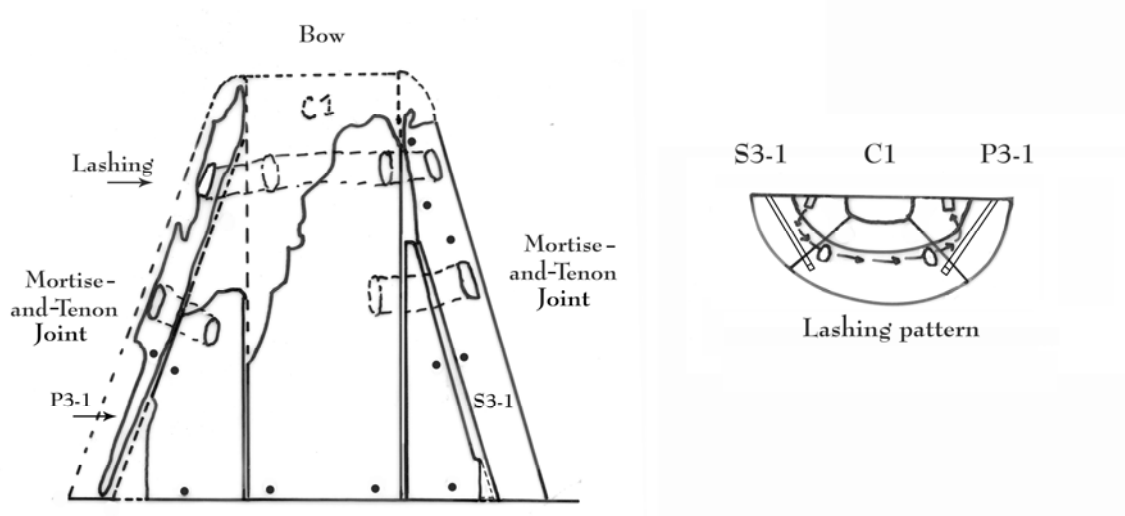

Figure 49. Lashing pattern at the bow of GC 4926 (P. Creasman).

Tool Marks

Several types of tools associated with the Middle Kingdom can be identified by their remaining marks and impressions. Plank ends reveal the use of saws in both ancient and modern times. Evidence of hammering is present from modern and ancient work as well.

Round impressions from standard or ball-peen hammers appear to be restricted to the top of strakes and to modern tenons. Impressions near ancient mortises correspond in size and curvature with several wooden hammers found in the museum.

Chisel marks are found inside mortises as mentioned above and adze marks can be seen on the outboard surfaces of most hull and deck planks (Figure 50). Chisel and adze marks can also be found on throughbeams and the quarter rudder stanchions.

At several places on the hull the wood is splintered and jagged (see throughbeam 3, Figure 50). The random arrangement and sharp corners of these marks suggest that they are modern, probably damage from shovels used during the boats' excavation.



Figure 50. Tool marks on throughbeam 3 and deck planks in section 4 (room D) of GC 4926 (P. Creasman).

Steering Arrangement

The steering arrangement is standard for an Egyptian funerary craft: one quarter rudder on either side of the stern. Each quarter rudder was secured to the boat at least at two points, and probably three. In order to fasten the quarter rudder, the top of its loom was lashed about three-quarters of the way to the top of the rudder stanchion, with the bottom of the loom resting on the crosspiece and the rudder blade tied to the boat. Alternately, the top of the loom may have rested on an upper crosspiece that was secured between the two stanchions but there is little archaeological evidence for this. It is uncertain if the blade was tied directly to the hull or to the bottom crosspiece; both methods are practical and serve the same function. It is not known if the loom was also

lashed directly to the crosspiece, but had it not been so steering would have been exceedingly difficult.

Two quarter rudders associated with this boat are stored beside it under a canvas drop cloth and not accessible for general viewing. They measure 3.14 m (QR1– Figure 51) and 3.62 m (QR2)¹⁷⁰ in length, with blades measuring 1.19 m long by 0.5 m wide and 1.24 x 0.55 m wide respectively. Each was originally constructed of three pieces: a long central piece and two wings at either side of it that complete the blade. The straight looms, having a maximum diameter of 10 cm half way up, were shaped from tree cores. The blade's wings are affixed to the central piece with pegged mortise-and-tenon joints 7.5 cm wide and 1.8 cm thick, of varying lengths. One blade wing of the blade on QR1 has a 2.5 x 2.7 cm square hole cut through it about 25 cm from the top. The same area in QR2 is not well preserved, subsequently few features can be positively identified. A rope would have run through this hole to secure the blade to the boat.

Rectangular tenons approximately 8 cm high and 3 cm squared are carved out at the top of the looms, without doubt to accept Horus-head carvings. Tillers were found on both quarter rudders and that of QR2 still remains partly in place. The tiller sockets are located between one-quarter and one-third of the way down from the top of the loom and measure 4 cm high by 5 cm wide, angled at about 45 degrees. The remains of both tillers are stored with the quarter rudders but are in poor and broken condition; they appear to have been about a meter long and 3-5 cm wide.

¹⁷⁰ Quarter rudder two was a subject of the 1999 repairs and has several well-reconstructed pieces.

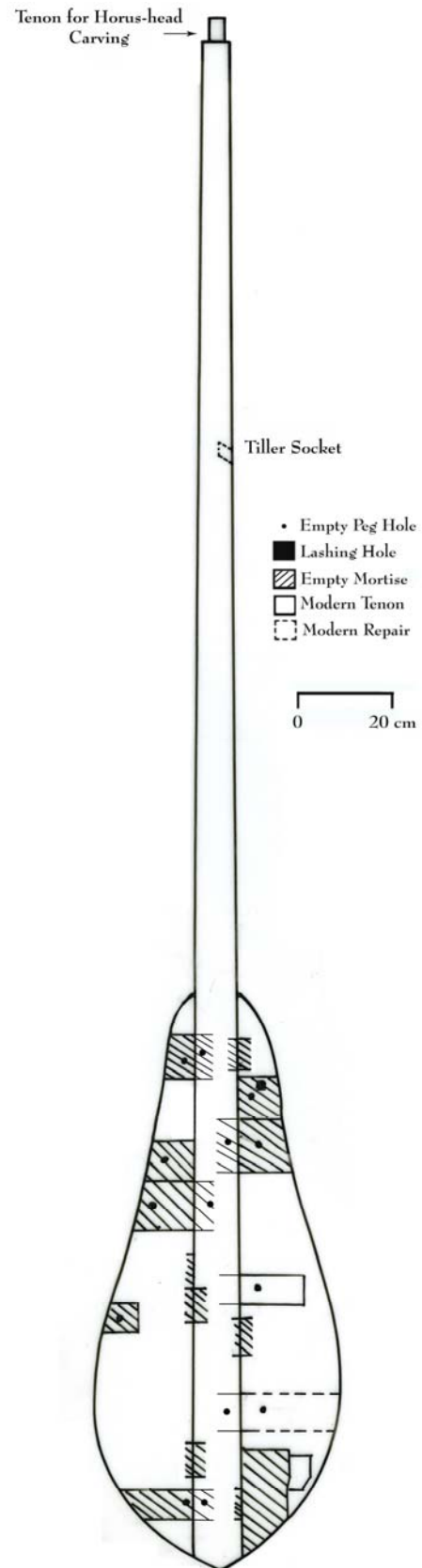

Figure 51. QR1 - Quarter rudder one, associated with GC 4926 (P. Creasman).

The two quarter rudder stanchions measure 1.65 m (starboard) and 1.47 m (port) in height and appear to be mismatched.¹⁷¹ The starboard stanchion is in good condition and still retains its Horus-head carving at the top while the port stanchion has suffered significant degradation, though not affecting its overall height. At the top they are round in section and abruptly change to square in section about 30 cm above where they pass through throughbeam 11. The diameter of the rounded area is approximately 10 cm for starboard and 9 cm for port with the width of the square areas 9 cm and 7.5 cm, respectively. Both stanchions rest in shallow divots fashioned in the hull plank below but it is uncertain how tightly they fit (Figure 52).¹⁷²

The starboard stanchion has a feature of unknown purpose: a small mortise on its outboard face, 15 cm below the base of the Horus-head carving, measuring 3 cm deep, 1.5 cm high, and 1 cm wide. The port stanchion has a similar mortise at the same relative height from the top of throughbeam 11 that is also on the outboard face. The port stanchion may have had other features but they are now unidentifiable due to damage.

Ornamentation

Horus-head carvings capped the tops and ends of all rudders, stanchions and crosspieces (Figure 53). The Horus-head that is still attached to the starboard stanchion measures 14.5 cm high, 13.0 cm wide at bottom, 7.5 cm wide at top, and 12 cm thick. Another Horus-head carving with identical measurements was stored with the quarter rudders but has been moved since January 2005. Each carving has a mortise in a side or the bottom to fit a tenon approximately 7.5 cm squared. There may be additional Horus-

¹⁷¹ Reisner (1913, 86) also seemed convinced the posts did not match, though his conclusion was based on paint scheme which is not distinguishable today.

¹⁷² See *ibid*, fig. 319.

heads in storage that are associated with this boat, which hopefully will be re-discovered during the museums' re-cataloguing project that is now underway; otherwise at least four of the carvings are unaccounted for.



Figure 52. Starboard quarter rudder stanchion socket, GC 4926 (P. Creasman).

The Horus-head carvings are reported to have blue-painted wigs, yellow faces, and green eyes, but on the two associated with this vessel no color whatsoever remains.¹⁷³ Little evidence of a crosspiece can be found with this boat, although one must have existed to support the quarter rudders. It would have sat at least half a meter aft of the stanchions to permit sufficient room to manipulate the quarter rudders.

¹⁷³ *Supra*, n. 132.

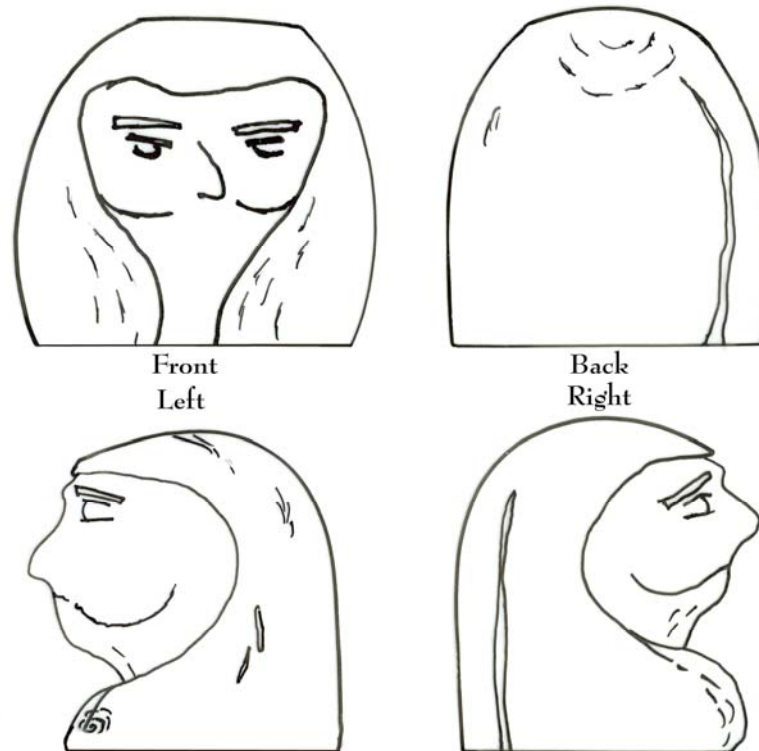

Figure 53. Views of a Horus-head carving (P. Creasman).

As the stanchions are fitted into the aft-most throughbeam, the crosspiece would have been extremely close to the stern and attached to the hull within 50 cm of the present terminus of the stern, and extended at least 50 cm over either side. The area where this would have been secured is missing on the port side and heavily damaged on the starboard. There are, however, remnants of a 3-cm square cavity in the top of plank S3-5 that corresponds to the likely placement of a crosspiece. The original crosspiece would have needed to be at least 1.6 m long in order to support the quarter rudders. Further dimensions of the crosspiece are not known but would resemble those on the de Morgan boat.

Semi-cylindrical rails were treenailed on top of strake 3 at the bow and stern: one at each quarter. The rails in the bow were approximately 75 cm in length and 5 cm wide at bottom, and are evidenced only by the presence of treenail holes and slight

impressions in the planks on which they rested. The two at the stern are assumed due to the extreme care taken to insure symmetry throughout the boat and are only evidenced by two treenail holes in the stern-starboard quarter. Those in the stern were probably much shorter than those in the bow due to restricted space caused by placing the quarter rudder stanchions in throughbeam 11.

Surface Decoration

The boat currently exhibits almost none of its originally fine painted characteristics, but has retained more pigment than any of the other Dahshur boats. The inboard face of the starboard weather strake is noticeably red and reveals both the upper layer of pigment and the underlying white primer. Black lines that are barely visible over the red pigment are the only evidence of images painted inboard and have not been recorded elsewhere. The black pigment is probably pyrolusite, an ore of manganese common in Sinai.¹⁷⁴ The design, as best can be determined, is a lotus-like flower, identical to that found on the quarter rudder that rests on deck of the de Morgan boat.

Using a layer of primer was common in ancient Egypt and it is present in small amounts all over the hull. White or yellow patches at the bow appear to be from primer but may actually be faded paint. Some patches of oxidized green pigment are still present over the white staining. The plaster-like substance can be found sporadically in chunks inside mortises and cracks throughout the hull. Conventional black-lights and higher powered ultra-violet lamps were cast over all surfaces of the hull but revealed no additional evidence of painted decoration.

¹⁷⁴ Lucas and Harris (1999, 340) note that the black pigment used in 12th-Dynasty sites at Beni Hassan was identified as pyrolusite, common in Sinai but not elsewhere in Egypt. Senwosret III led at least one expedition to Sinai and began to re-open the mines.

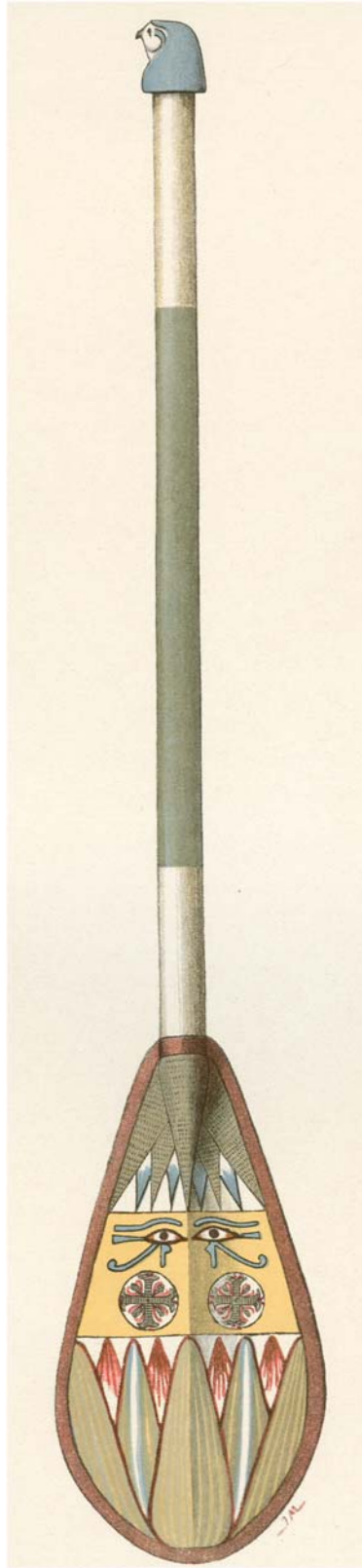

Figure 54. Quarter rudder with udjat eyes, lotus flowers, and papyrus leaves (from de Morgan 1895, pl. XXXI).

Quarter rudder two retains very light staining of black paint in the figure of an udjat. Originally, there were more finely painted details on the blade of the quarter rudders, but they are now lost. Figure 54 shows de Morgan's rendition of a quarter rudder's decoration, and it may be assumed that all would have been similar, if not identical.

This boat also shows damage from years of touching by visitors to the museum. Since there is comparatively good preservation of pigment on the starboard side of the weather strake, similar preservations probably would have been found on the port side had it not been exposed to largely unrestricted handling over the years.

ANALYSIS

Previous studies of the Cairo boats have primarily repeated the findings of prior works that can be traced back to de Morgan and Reisner,¹⁷⁵ with limited detail coming to light. The purpose of this study is to bring these mostly overlooked two boats in Cairo into the discussions of the history of shipbuilding technology. Since Ward completed the first intensive study of the two Dahshur boats in the United States, subsequent works have categorized all the Dahshur hulls in like context with little attention paid to differences within the group. While many of the construction methods and elements are relatively consistent among the boats, including mortise-and-tenon joints, dovetail fastenings, and fitted hull planking, there is still much to be learned from the Cairo boats.

The assumed purpose of the vessels remains the same, as the Cairo boats offer additional evidence for their role as funerary craft in style, function, and shape. The boats themselves mirror Middle Kingdom ceremonial model boats with papyriform shape, white decks, red throughbeams,¹⁷⁶ and either green or yellow hulls. Other decorations such as udjat eyes for protection, the presence of Horus to watch over the pharaoh on his journey, and papyrus and lotus representations symbolizing the unification of Upper and Lower Egypt are common to all four boats. Depositing the boats beside Senwosret III's pyramid was not an easy task, as eight kilometers (five miles) of slightly uphill desert terrain had to be traversed to transport them from the

¹⁷⁵ Reisner's drawings are adaptations from those of de Morgan, though his description is quite original. Other works, including those of Landström (1970), Casson (1971), Göttlicher and Werner (1971), Haldane (1984, 1993), and Ward (2000) include some original material regarding the Cairo boats but none treat them comprehensively. Most references to the Dahshur boats are rooted in the study of the vessels in the United States.

¹⁷⁶ The throughbeams, even if they were not painted would still have appeared red as visual inspection can determine that they are in the same family as cedar, if not cedar itself.

banks of the Nile. While we may never learn for sure who owned the boats, it is not necessarily ownership but the purpose of the vessels that significantly contributes to a better understanding of the development of watercraft; and, for students of ancient ships and of ship construction, it is the vessel itself that provides the most critical information.

Lines drawings (Figures 15 and 39), construction plans (Figures 21 and 40), flattened planking plans (Figures 22 and 41), and three-dimensional renditions (Figures 55 and 56) of both boats illustrate well conceived, planned, and executed vessels. The boats are fuller slightly aft of midships, lightly-drafted, and sturdily built. Regardless of whether or not they made repeated trips or were used only once for the final ceremonial voyage to Abydos to prepare the pharaoh for the afterlife, the boats were extremely durable and would have endured hardship from continuous use.

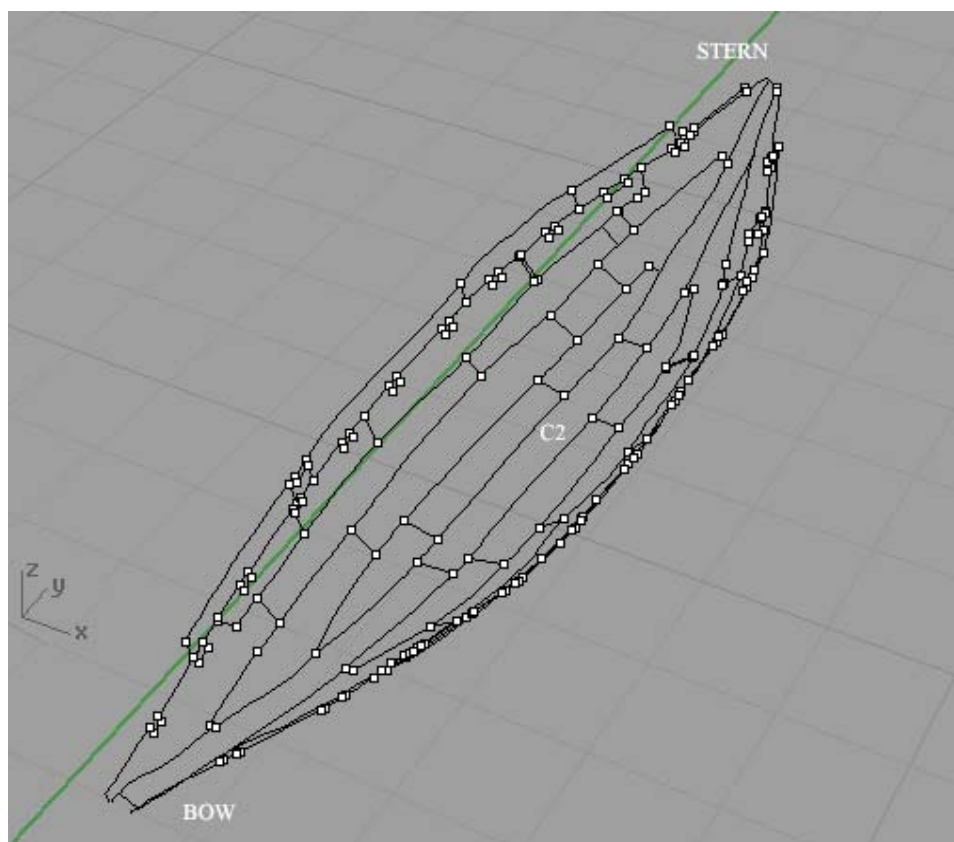

Figure 55. Three-dimensional rendition of the de Morgan boat (T. Larson).

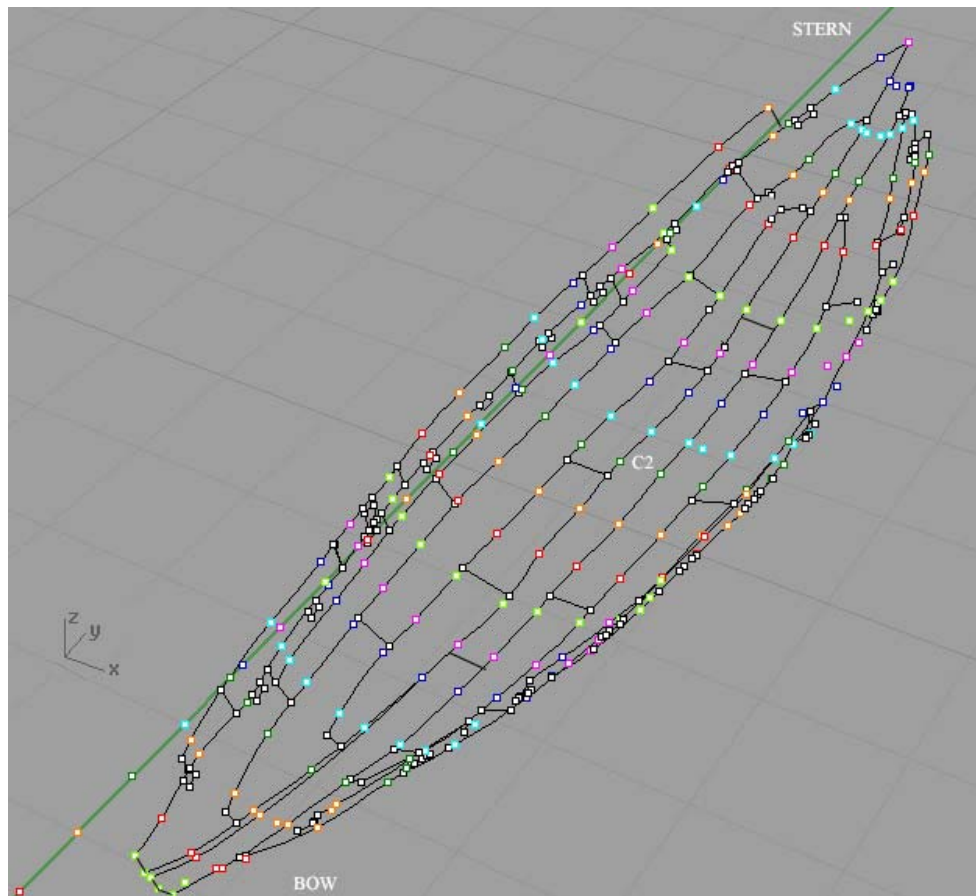

Figure 56. Three-dimensional rendition of GC 4926, with data points (T. Larson).

The shallow-draft boat design developed at least 3000 years prior to the construction of the Cairo boats and probably much earlier. It was ideal for negotiating the seasonally fluctuating depths and sand bars of the Nile. Constructing the vessel with arch-shaped sections and fuller aft of midships ensured stability with heavy loads on the deck, such as a sarcophagus. Fashioning a flat bottom, particularly at the bow, by beveling the center strake permitted effortless beaching of the boats on the sandy banks of the Nile while maintaining its stability while on land. Such a construction also prevented the boat from becoming lodged in shallow sand bars. Even though most hull timbers of these boats show evidence of reuse in ancient times, which include large holes

below the waterline, such features were patched with plaster and perpendicular tenons of the size and shape that provided structural integrity.

The majority of the structural integrity came from the culmination of a few ingenious methods. Merging old technology with relatively new technology is what made the Dahshur boats sound craft. Longitudinal integrity began with the design of the center strake, which is at least 10 percent thicker than all the other strakes in the hull and provides the backbone of the boat. The highest frequency of mortise-and-tenon joinery in the hull is found on the center strake, further reinforcing the boats' foundation. Dovetailing is also the most frequent on the central strake, and their use either as dovetails or lashings would have had the same end result of supporting the boat.

The consistency of measurements found throughout the Cairo hulls confirms Haldane's¹⁷⁷ assertion that a standard system of measurement was employed in the design and execution of the boats: the Egyptian cubit, palm, and digit.

The application and benefits of arches in ancient Egyptian boatbuilding are well documented,¹⁷⁸ and the Egyptians were aware of the problems of hogging and sagging at least as early as the 4th Dynasty and probably even before. In the Cairo Dahshur boats the arch concept is applied in section and would have efficiently redistributed stresses. When the boats are viewed in a sheer plan the addition of "decorative" finials appear to create a massive inverted arch; however, the lack of significant down forces on the finials voids the benefits inherent in an arch.

¹⁷⁷ For the sake of comparison I am applying the conversions used by Haldane (1984, 98). A cubit is equal to 52 cm, which can be divided into 7 palms of 7.5 cm each, or 28 digits of 1.87 cm each.

¹⁷⁸ Haldane 1984, 90-3; see also Bell 1933; Hornell 1970, 215-17; Hausen 1979, 211-30.

The planks of the central strake and those that comprise the rest of the hull up to strake 4 are alternated fitted planks.¹⁷⁹ Placing a plank's strongest and widest part next to the weakest points in the vessel (i.e., the butt joints in adjacent strakes) efficiently redistributed stresses. Double lashing of the weather strake only at the central-most joint confirms that the boat builders were aware of where joints would require reinforcement.

The concept of redistributing stress was already old by the time the Dahshur boats were built; it had been dealt with in a similar fashion at least 500 years prior, as seen in the joggling on the Khufu barge timbers. But joggling was unnecessary for vessels of only 10 meters, especially when built using large mortise-and-tenon joinery. In addition to pairing weak points with strong points in the hull, these pairings were mirrored on either side of the central strake. By placing joints as far apart from one another on adjacent strakes as was possible, the stresses on the vessel were distributed relatively equally, thereby maximizing the strengths and minimizing the weaknesses of the planks.

Planks were joined by the earliest known use of regularly spaced deep mortise-and-tenon joinery,¹⁸⁰ which added considerable longitudinal strength to the vessel. Between the mortise-and-tenon joints, gravitational force, and the added weight of the weather strake, to be discussed presently, the hull planks were kept properly aligned. Lashing of the weather strake planks together also contributed to the longitudinal integrity of the boat,¹⁸¹ like a stringer, and when the weather strake, as a single unit, was lashed to the hull it aided the necessary compression of the hull below it.

¹⁷⁹ Called "top and butt" planking by Steffy (1994, 291).

¹⁸⁰ Ward 2000, 83-4; see also Haldane 1984, 23.

¹⁸¹ An interesting case for the weather strake evolving from stringers is presented by Ward (2000, 101-102).

The weather strake overlapped all but the first and last throughbeams on both Cairo boats. As the throughbeams were prevented from shifting transversally by shaped ends and rectangular treenails, the only way they could move when load was applied would have been up, if not for the weather strake holding them in place. The throughbeam and weather strake combination played a significant part in retaining the transverse integrity of the hull: the only other evidence of transverse stiffening is the dovetails.

Arguments have been made suggesting an alternate interpretation of the dovetail fastenings, most notably by Ward (Figure 13).¹⁸² The interpretation of dovetail joints as originally having been lashing mortises that were modified since excavation is credible, is congruent with earlier ancient Egyptian boatbuilding techniques, and may have been more forgiving when stress was redistributed through the hull. The evidence from the Cairo boats alone does not support such an interpretation of lashings as the original fastenings of the boats in place of dovetails. The dovetails remain the least understood aspect of these vessels' construction.¹⁸³

Yet, a strong case for the use of dovetails as the original fittings of the Cairo boats can also be made. The dimensions of the dovetails are comparable to those of ancient mortise-and-tenon joints and can be understood in the terms of ancient Egyptian measurement. A typical dovetail is about two palms in length, three digits in maximum width, one to two digits in minimum width and two digits in depth. This is to be expected, and even in Ward's argument that the dovetail mortises were actually lashing holes, these too would have been measured in cubits, or some division thereof.

¹⁸² 2000, 93-96.

¹⁸³ Haldane 1996, 239; the dovetails have become a prominent enough feature in Egyptian shipbuilding to have found their way into popular works and illustrations, notably by Foster and Brock (1998).

More substantial evidence comes in the form of several sledges that de Morgan found buried next to the Dahshur boats. From Egyptian iconography it is clear that such sledges were used to transport boats over land.¹⁸⁴ One sledge recorded by de Morgan¹⁸⁵ measured about 4.1 m long, and a second recorded by Reisner measured 4.21 m long.¹⁸⁶ A third sledge which matches neither de Morgan's nor Reisner's drawings, is displayed in the Egyptian Museum (Figure 57).¹⁸⁷ All three sledges have at least one beam that employs a dovetail fastening to secure it to the main timbers. All of the dovetailing are ancient and demonstrate that at the time the Dahshur boats were interred Egyptians were using such a fastening method in context with boats. Also, recent excavations at the 12th-Dynasty port of Wadi Gawasis have uncovered boat or ship timbers that reportedly use dovetails in the same manner as on the Dahshur boats.¹⁸⁸ Dovetails as a primary construction element could have been imported technology from any one of the lands Senwosret III and the other 12th-Dynasty pharaohs conquered. They may also represent an abandoned method in the evolution of ship fastenings.¹⁸⁹

¹⁸⁴ Ward 2000, fig. 49.

¹⁸⁵ 1895, fig. 204.

¹⁸⁶ 1913, fig. 326.

¹⁸⁷ GC 5460. To my knowledge this artifact has yet to be published.

¹⁸⁸ Personal communication Kathryn Bard, 23 April 2005. Bard is a CAS associate professor of archaeology at Boston University and co-director of excavations at the Middle Kingdom port of Wadi Gawasis. These timbers have yet to be published or thoroughly inspected by a nautical archaeologist, thus this information is tentative.

¹⁸⁹ See Gould (1982) for a discussion of punctuated equilibrium, which could account for the sudden appearance and apparent disappearance of a "new" construction method, such as dovetails.



Figure 57. A sledge found with the Dahshur boats and close up of ancient dovetail joint (P. Creasman).

Ward's argument for the existence of lashings in place of dovetails is based largely on eroded original fastenings found on the Carnegie boat.¹⁹⁰ Ward attributes the damage at the ends of the dovetails' sockets as compression from wear by lashings, but such markings on the Cairo boats are identical to the damage caused by chisels at edges of mortises.¹⁹¹ It is more likely that both types of damage were caused by the same source: the chisels used to cut the sockets. The Cairo Dahshur boats retain no other evidence of the type offered by Ward in support of her argument; such as eroded fastenings or ligature fibers in dovetail sockets. The only evidence for the use of ligatures on either Cairo hull is on the weather strake and at the bow and stern where decorative false stem and stern posts would have been lashed into place.

For some researchers, the definitive proof for the existence of lashings on the Dahshur boats is in their practicality. Lashings would have allowed the hull to be caulked or seams pulled tight to render the vessel water tight. But, the dovetails would have sufficed in this respect as well; moreover, there was no need for the boats to have been water tight.¹⁹² The area below deck was not intended to carry goods, as evidenced by permanently securing the deck planking to throughbeams and to the hull, thus impermeability below the deck would have been unnecessary. Some small leaks would probably have been common, but presented little problem to overall structural integrity.

Lashings, as evidenced by a groove in the stern of the de Morgan boat (Figure 17) and channels carved in the bow of both boats and stern of GC 4926 (Figures 27 and 49), likely served a dual purpose. Generally, the primary purpose for these is assumed to be to secure the end posts or finials, but since the groove and channels connect the third

¹⁹⁰ 2000, 93-4, specifically figs. 43 and 44.

¹⁹¹ Ward (2000, 92) attributes the damage around mortise edges to crushing from chisels.

¹⁹² Bell 1933, 102; see also Steffy 1994, 36.

port and starboard strakes with the central stoke, they effectively bind the ends of the boat. The channels facilitate lashing for structural integrity, while the grooves accommodate an exterior overlapping, likely used to secure decorative additions.

It is not surprising that the best evidence for the use of ligatures is found at the bow and stern and in the weather stoke. Throughout history when shipwrights or shipbuilders employed new methods, as seems to be the case with the use of dovetails, they frequently reverted to using older traditional methods in the more difficult or critical places for reassurance purposes. In the case of the Dahshur boats, the most difficult places would have been securing the bow and stern, but preventing the throughbeams from upward movement under stress would have been just as critical.

All but the fore-and-aft most original throughbeams on both boats were broken near their middle, generally over a square recess in the central stoke. The recesses most likely held small stanchions to support the longest throughbeams at the middle; such support was not necessary on shorter throughbeams in the bow and stern, which, consequently, have no corresponding recesses. The evidence of stanchions suggests two things: the builders had experienced this problem in the past and knew how to counteract it, and that these boats were intended for long term use or to carry heavy burdens. Stress-testing of modern cedar (*Cedrus libani*) and sidder (*Zizyphus spina-christi*)¹⁹³ timbers cut of heartwood to the dimensions of the longest throughbeams from each hull indicates that stanchions would only have been necessary if extremely heavy loads were carried or

¹⁹³ The Egyptian Museum restorers believe this to be the type of wood used in the Dahshur hulls, it is also called 'Christ's thorn' and *nabk*. Sidder is a hard durable wood that thrives in hot dry climates, particularly in North Africa and does not grow much taller than five meters. Sidder was common in ancient Egypt, and was generally used for small objects until the 11th Dynasty when it became common in coffins (Stewart 1995, 40-1).

if longevity of the beams was a concern.¹⁹⁴ In the case of the Dahshur boats, it is likely that the builders addressed the latter concern, for the boats were likely intended to last for eternity. For a one-time ceremonial trip from the Faiyum to Abydos and finally to Dahshur such supports would have probably been unnecessary.

Half-mortises present at the outboard corners of almost every plank in the Cairo boats have previously been interpreted simply as mortise-and-tenons joints.¹⁹⁵ While this seems the most practical explanation, and it would have significantly increased overall strength of the hull, the absence of corresponding mated mortises on most outboard planks requires another interpretation. Perhaps the half-mortises are from a previous use of the timbers, and it was not deemed necessary to reinforce the hull by cutting the extra mortise on the adjacent plank when building the boats, but their consistency is too great to be discounted. As the Egyptians were aware of the weakness inherent in a joint, as evidenced by the tight fitting of planks to one another, it is surprising that they would not have reinforced the planks with tenons at their corners.

Another possible use for the half-mortises is as guide marks for assembly of the planks.¹⁹⁶ While boat builders were assembling pre-fashioned timbers,¹⁹⁷ it would have been convenient to use mortises to secure plank ends while refinements were being made on them. If the half-mortises do indeed represent construction guides, then they could provide evidence for a building process that may have been an ancestor of what Herodotus described in his *Histories* II. Herodotus' recording of Egyptian ship

¹⁹⁴ These empirical tests were conducted in Cairo with the help of several local woodworkers and an engineer.

¹⁹⁵ Ward 2000, 85-7; Haldane 1984, 23-4.

¹⁹⁶ Haldane (1984, 98) notes that on the Khufu barge the mortise-and-tenon joints served "only to align the planks."

¹⁹⁷ See Newberry 1893, pl. xxxix.

construction in the fifth century B.C is often overextended to include the Dahshur boats and any number of other vessels, despite gaps of over a millennium. He describes a ship being assembled like stacking bricks one on another, and approximately 1300 years earlier such a method was employed for the Dahshur boats. It is possible that the guided method Herodotus recorded evolved from such earlier guides like the half-mortises present in the Cairo Dahshur boats. The concept of guiding curvature of the hull is the same in both instances and it would not have been a far step from using guides in the vessel itself, as with the Dahshur boats, to constructing an external sling, as described by Herodotus.

General construction of the Cairo boats is mostly in accordance with Haldane's description regarding the Chicago and Pittsburgh boats.¹⁹⁸ The process was probably based on standards or rules-of-thumb regarding the shaping, narrowing, and fitting of hull timbers, as suggested by the presence of uniform symmetry throughout the boats. Deviation from symmetry is due primarily to damage or modern repairs.

The design process would have begun with a basic length-to-beam ratio of 4:1 in mind, as demonstrated by the hulls of numerous models and all Dahshur boats. The first strake fashioned was probably C2, from which the gradual reduction of the sided dimensions in each subsequent strake would have been derived. The basic sizes and shapes of hull planks were cut before assembly. Once placed on the previous plank, trimming and fitting would have been conducted mostly in place, although timbers would have been removed if larger adjustments were necessary. This process continued up to strake 4 when measurements for throughbeams were taken and their sockets were

¹⁹⁸ 2000, 96-102; Haldane 1984, 95-6.

cut on strakes 3 and 4. Fine trimming of the hull was probably made while the throughbeams were treenailed into place.

The throughbeams were affixed to the hull by hammering a semi-rectangular peg into a round hole. This is a common wood working practice even today, and provides a tighter fit when the wood swells, as is evidenced on GC 4926. The port end of throughbeam 9 and the strake below have round holes where square ones are expected. These round holes are in a significantly better condition and do not exhibit the signs of wear found on their square equivalents. If the boat builders had missed, or deemed it unnecessary to insert a rectangular peg in this throughbeam, it would explain why it retains its rounded shape. After 4000 years of retaining a square peg the other round holes would have slightly changed shape.

Throughbeams were most likely fashioned after the hull was completed to the fourth strake and placed at predetermined intervals such as every 29 or 30 palms. The port socket of throughbeam 10 on the de Morgan boat is particularly revealing regarding the design and implementation of throughbeams (Figure 58), as are throughbeams 3 and 8 on GC 4926, which were previously discussed.

The placement of throughbeam 10 at the end of a strake scarf suggests that it was not planned out prior to being added. If throughbeam placement had been planned, as the rest of the timbers were, it is extremely unlikely the same designers who made the effort to distribute joints as far apart as possible would have intended the end of the throughbeam to coincide with the end of a plank, thus weakening the joint further.

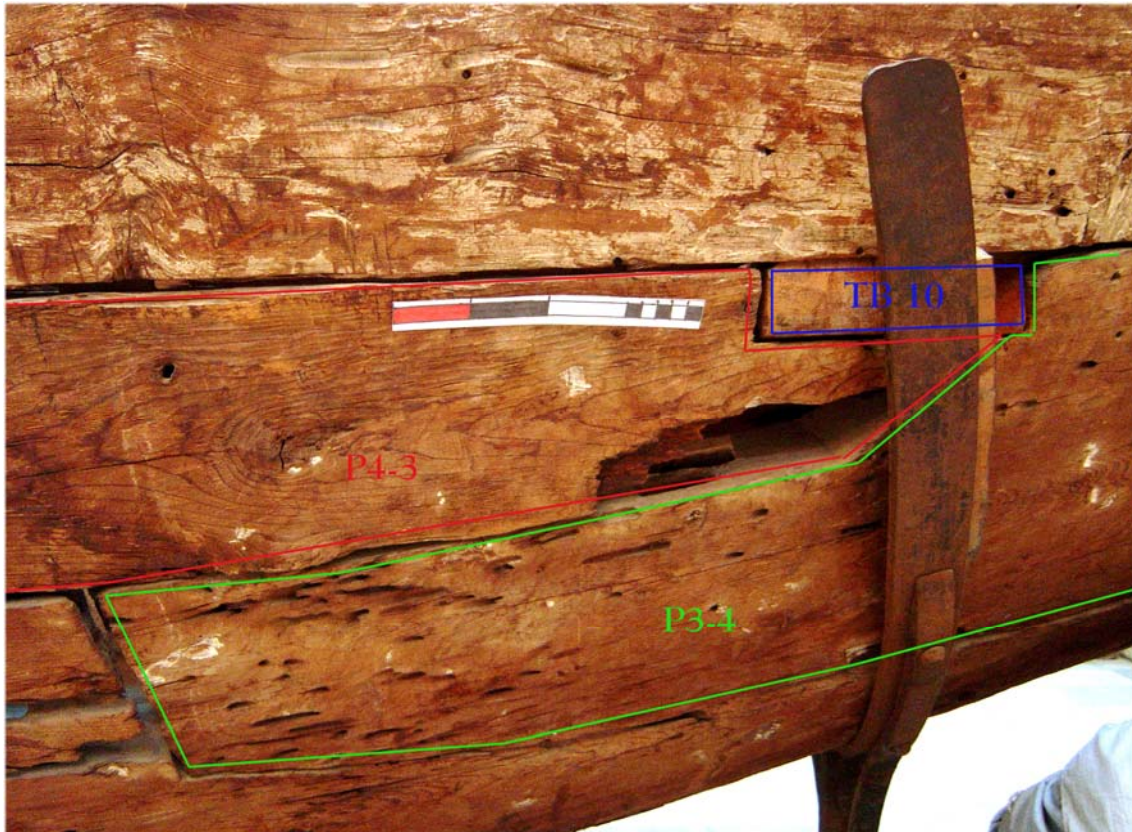

Figure 58. Port end of throughbeam 10 on the de Morgan boat (J. Levin).

Once the throughbeams were secured in place the weather strakes were probably the next addition. It is tempting to think that the weather strakes were added after the deck planks were installed but several dovetails fasten strake 4 to the weather strake on the de Morgan boat; these had to have been added prior to installing the deck planking. If, on the other hand, the dovetails joining strakes 4 and 5 are modern additions, then the dovetails and lashings could have been added at anytime up to the addition of the deck planks. It is also possible that the weather strake was added after the deck planks, ensuring that the outermost deck planks butted tightly to the inboard edge. After the deck was secured it would have been a simple task to add the weather strake plank by plank, lash it together, and finally lash it to the hull.

The general condition of the underside of the extant deck planking suggests that deck planking was the last practical application for recycled timbers. They have the most damage, highest frequency of excess mortises and, if tested, most would likely yield 14C dates noticeably older than those of the hull planking. Interestingly, the smallest planks (those in rooms A on both boats and room L on the de Morgan boat) are devoid of damage and unnecessary mortising on the underside. These small planks were probably excess trimmings from the hull timbers or other pieces fashioned specifically for use in the vessels: efforts to conserve resources are apparent.

In whatever form that decorative endposts were present, they would have been added after the deck planking, along with the quarter rudder stanchions. The hull would then have been primed and painted, prior to adding the quarter rudders.

It is possible that a light canopy superstructure was pegged into the deck planking, as evidenced by small square holes in several planks and as seen on many boat models and reliefs from the Middle Kingdom. Although, with the prevalent evidence of reused material, it is possible that the square holes in the deck planks simply represent signs of such practice.

The deck planking arrangement is perhaps the most intriguing aspect of the Cairo boats. Deck planking of the de Morgan boat, spanning multiple rooms and pegged to the throughbeams, effectively make the entire deck behave as a single unit is redistributing weight. The difference in the two deck arrangements of the Cairo boats raises the question "why?" It is tempting to account for the differences as ceremonial or religiously rooted, but this is insufficient. The difference from rabbeting the throughbeams and

leaving them exposed, to planking over the throughbeams could not have been made by one boat builder or designer—these are two distinct trends.

Prior to the Industrial Revolution most shipbuilding and design was passed down within a family or from a master to an apprentice. Assuming this was the case in ancient Egypt, as the limited records on the subject indicate, then a viable explanation for the difference in deck arrangements on the Cairo boats could be due to different families or yards being responsible for their construction. It was people who designed and built the Dahshur boats and they left their marks on their product, physically and conceptually.

CONCLUSIONS

The description and analysis of the two Dahshur boats presented here was pursued out of a perceived shortcoming in the analysis of the Dahshur boats as a whole. The "opportunity to study four contemporary Bronze Age hulls"¹⁹⁹ has not been possible prior to this study as detailed recordings of the Cairo boats had not been produced. There was no perceived disservice in discounting these two boats in the study of the Dahshur boats as a whole, primarily because the recordings of the two vessels in the United States were thorough, but perhaps now a more comparative study can be made.

With over two years of study and more than six weeks of interaction with the Cairo boats I came to understand how well conceived, well executed, and practical the boats were, despite their appearance. Seemingly simple adaptations such as stanchions under a throughbeam or fashioning the ends of throughbeams into a wedge shape to prevent lateral movement were critical to the integrity of the hulls. Even though the boats were designed to be towed²⁰⁰ they could have withstood self-propulsion whether by current, wind, or man-power. The culmination of over 3,000 years of experience in building watercraft is incorporated into the form and construction of these two vessels. Did these vessels represent the pinnacle of Middle Kingdom shipbuilding? Certainly not, but they were important enough to be buried eight kilometers off the banks of the Nile to accompany a pharaoh in his afterlife.

The Dahshur boats came from a time when Egypt was undergoing a drastic change both physically and socially. History demonstrates that such major changes are sometimes reflected in changes in technology. The Dahshur boats, as a whole, can now

¹⁹⁹ Haldane 1984, iii.

²⁰⁰ See Appendix E for an example of how the Dahshur boats were most likely transported.

take their place in the progression of shipbuilding in ancient Egypt and the Mediterranean.

WORKS CITED

- Allen, J.P. 2000. *Middle Egyptian: An Introduction to the Language and Culture of Hieroglyphs*. Cambridge: Cambridge University Press.
- Bard, K. 2004. "Emergence of the Egyptian State." In *The Oxford History of Ancient Egypt*, edited by I. Shaw, 57-82. Oxford: Oxford University Press.
- Bass, G.F., ed. 1972. *A History of Seafaring Based on Underwater Archaeology*. London: Thames and Hudson.
- Bell, C.D.J. 1933. "Ancient Egyptian Ship Design; Based on a Critical Analysis of the XIIth Dynasty Barge." *Ancient Egypt and the East* III-IV: 101-110.
- Breasted, J.H. 1906. *A History of Egypt*. London: Hodder and Stoughton.
- Bryan, B.M. 2004. "The 18th Dynasty before the Amarna Period." In *The Oxford History of Ancient Egypt*, edited by I. Shaw, 207-264. Oxford: Oxford University Press.
- Budge, E.A.W. 1990. Reprint. *The Book of the Dead*. New York: Carol Publishing Group. Original edition, London: The British Museum, 1894.
- Callandar, G. 2000. "The Middle Kingdom Renaissance." In *The Oxford History of Ancient Egypt*, edited by I. Shaw, 148-183. Oxford: Oxford University Press.
- Casson, L. 1971. *Ships and Seamanship in the Ancient World*. Princeton: Princeton Press.
- Creasman, P.P. 2005. "The Cairo Dashur Boats." *INA Quarterly* 32.1:15-19.
- Davies, W.V. 1987. *Catalogue of Egyptian Antiquities in the British Museum VII Tools and Weapons*. London: The British Museum.
- de Morgan, J.J. 1895. *Fouilles à Dâhchour: Mars-Juin 1894*. Vienna: Adolph Holzhausen.
- _____. 1896. "Account of the Work of the Service of Antiquities of Egypt and of the Egyptian Institute During the Years 1892, 1893, and 1894." Annual Report of the Board of Regents of the Smithsonian Institution July 1896, Washington DC.
- _____. 1897. "Note sur les travaux du service des antiquités de l'Égypte et l'Institut Égyptien pendant les années 1892, 93 et 94." Annual reports to the Dixième Congrès International des Orientalistes, session de Genève 1894, 3-33. Leide.

- Edgerton, W. 1923. "Ancient Egyptian Ships and Shipping." *American Journal of Semitic Languages* 39:109-135.
- Erman, G.A. 1971. *Life in Ancient Egypt*. London: Dover Publications.
- Faulkner, R.O. 1981. *A Concise Dictionary of Middle Egyptian*. Oxford: Griffith Institute.
- Foster, J.L., and L.P. Brock. 1998. *The Shipwrecked Sailor: A Tale from Ancient Egypt*. Cairo: The American University in Cairo Press.
- Franke, D. 1994. *Das Heiligtum des Haqaib auf Elephantine: Geschichte eines Provinzheiligtums im Mittleren Reich*. SAGA 9. Berlin: Heidelberger Orientverl.
- Frothingham Jr., A.L. 1895. "Archæological News: Summary of Recent Discoveries and Investigations." *American Journal of Archaeology and of the History of the Fine Arts* 10.1:65-136.
- Glanville, S.R.K. 1972. *Catalogue of Egyptian Antiquities in the British Museum II*. Oxford: The British Museum.
- Goedicke, H. 1968. "Remarks on the Hymns to Sesostris III." *Journal of the American Research Center in Egypt* 7:23-37.
- Goodman, W.L. 1966. *History of Woodworking Tools*. London: G. Bell and Sons.
- Göttlicher, A., and W. Werner. 1971. *Schiffsmodelle im Alten Ägypten*. Wiesbaden: Arbeitskreis Historischer Schiffbau e.V.
- Gould, S.J. 1982. "The Meaning of Punctuated Equilibrium and Its Role in Validating a Hierarchical Approach to Macroevolution." In *Perspectives on Evolution*, edited by R. Milkman. Sunderland: Sinauer Press.
- Grajetzki, W. 2003. *Burial Customs in Ancient Egypt: Life in Death for Rich and Poor*. London: Duckworth Co. & Ltd.
- Griffith, F.L. 1898. *Hieratic Papyri from Kahun and Gurob*. London: Bernard Quaritch.
- Haldane, C.W. 1984. "The Dashur Boats." M.A. thesis, Texas A&M University.
- _____. 1985. "A Fourth Dahshur Boat." *Journal of Egyptian Archaeology* 71:174-175.
- _____. 1993. "Ancient Egyptian Hull Construction." Ph.D. diss., Texas A&M University.

- _____. 1996. "Ancient Egyptian Hull Construction." In *Tropis IV*, edited by H. Tzalas, 235-244. Athens: Hellenic Institute for the Preservation of Nautical Tradition.
- Hassan, S. 1946. "The Boats of Dahshur." In *Excavations at Giza Vol. VI Part 1* by S. Hassan, 157. Cairo: Egyptian Government Press.
- Hausen, J. 1979. *Schiffbau in der Antike*. Herford: Koehlers Verlagsgesellschaft mbH.
- Hocker, F. 1998. "Ship Construction." In *Seagoing Ships and Seamanship in the Bronze Age Levant*, by S. Wachsmann, 215-244. College Station: Texas A&M University Press, Chatham Publishing.
- Holland, W.J. 1903. "A Boat 4,500 Years Old." *Biblia XV*: 77-78.
- Hornell, J. 1970. *Water Transport*. 2nd ed. London: Devon Press.
- Jenkins, N. 1980. *The Boat Beneath the Pyramid*. New York.
- Jones, D. 1990. *Model Boats From the Tomb of Tut'Ankhamūn*. Tut'Ankhamūn's Tomb Series IX. Oxford: Griffith Institute, Alden.
- _____. 1995. *Boats*. Austin: The University of Texas Press.
- Landström, B. 1961. *The Ship: An Illustrated History*. Garden City: Doubleday and Company Inc.
- _____. 1970. *Ships of the Pharaohs*. Garden City: Doubleday and Company Inc.
- László, V., and R. Woodman. 1999. *The Story of Sail*. Annapolis: Naval Institute Press.
- Lipke, P. 1984. *The Royal Ship of Cheops*. BAR International Series 225. Oxford.
- Lonely Planet. 2004. *The Lonely Planet Guidebook: Egypt*. Oakland: Lonely Planet.
- Lopez, J. 1963. "Le Papyrus Millingen." *Revue d'Égyptologie* 15: 29-33, pl.4-8.
- Lucas, A., and J.R. Harris. 1999. *Ancient Egyptian Materials and Industries*. Mineola: Dover Publications, Inc. Original edition, London: Edward Arnold Publishers Ltd., 1962.
- Magoffin, R.V.D., and E.C. Davis. 1929. *The Romance of Archaeology*. Garden City: Garden City Publishing Company, Inc.
- Newberry, R.G. 1893. *Beni Hassan I*. London: Kegan Paul, Trench, Trübner and Co.

- Nour, M.Z., Z.Y. Iskandar, M.S Osman, and A.Y. Moustafa. 1960. *The Cheops Boat*, Part I. Cairo: Egyptian Government Press.
- Obsomer, C. 1995. *Sesostris I^{er}: Étude chronologique et historique de règne*. Connaissance de l'Égypte Ancienne 5. Brussels.
- Parkinson, R.B. 2002. *Poetry and Culture in Middle Kingdom Egypt: A Dark Side to Perfection*. London: Continuum.
- Partridge, R. 1996. *Transport in Ancient Egypt*. Gilford: Biddles Limited.
- Patch, D.C. and C.W. Haldane [Ward]. 1990. *The Pharaoh's Boat at the Carnegie*. Pittsburgh: The Carnegie Museum of Natural History.
- Peet, Rev. S.D., ed. 1902. "Ancient Boat From the Nile." *American Antiquarian and Oriental Journal* 24: 187-188.
- Petrie, W.M.F. 1916. *Tools and Weapons of Egypt*. London: Aris & Phillips.
- Reisner, G.A. 1913. *Models of Ships and Boats. Catalogue General 4798-4976 et 5034-5200*. Cairo: L'Institut Français D'Archéologie Orientale.
- Shaw, I. 2000. "Introduction Chronologies and Cultural Changes in Egypt." In *The Oxford History of Ancient Egypt*, edited by I. Shaw, 1-17. Oxford: Oxford University Press.
- Sliwa, J. 1975. *Studies in Ancient Egyptian Handicraft: Woodworking*. Warsaw: Panstwowe Wydawnictwo Naukowe.
- Steffy, J.R. 1994. *Wooden Ship Building and the Interpretation of Shipwrecks*. College Station: Texas A&M University Press, Chatham Publishing.
- Stewart, H.M. 1995. *Egyptian Shabtis*. Buckinghamshire: Shire Publications.
- Throckmorton, P. 1987. *The Sea Remembers*. New York: Weidenfeld and Nicolson.
- Tooley, A. 1995. *Egyptian Models and Scenes*. Shire Egyptology Series. Buckinghamshire: Shire Publications Ltd.
- Trigger, B.G. 1993. *Early Civilizations; Ancient Egypt in Context*. Cairo: The American University in Cairo Press.
- Vinson, S. 1994. *Egyptian Boats and Ships*. Shire Egyptology Series. Buckinghamshire: Shire Publications Ltd.

- Ward, C.A. 2000. *Sacred and Secular: Ancient Egyptian Ships and Boats*.
Archaeological Institute of America Monographs No. 5. Philadelphia: University
of Pennsylvania Museum.
- _____. 2004. "Boatbuilding in Ancient Egypt." In *The Philosophy of Shipbuilding:
Conceptual Approaches to the Study of Wooden Ships*, edited by F. Hocker and
C. Ward, 13-24. College Station: Texas A&M University Press.
- Wassersport. 1906. "Eni viertausendjähriges Boot." In *Wassersport* 4:6-7.
- Weigall, A. 1927. *A History of the Pharaohs*. Vol. 2, *From the Accession of Amenemhet
I of the Twelfth Dynasty to the Death of Thutmose III of the Eighteenth Dynasty,
2111 to 1441 B.C.* New York: E.P. Dutton and Company.
- Winlock, H.E. 1955. *Models of Daily Life in Ancient Egypt from the Tomb of Meket-Re
at Thebes*. Cambridge: Harvard University Press.
- Winslow, Rev. W.R. 1894. "Egyptological Notes." *American Antiquarian and Oriental
Journal* 16: 306-307.
- _____. 1895. "Egyptological Notes." *American Antiquarian and Oriental
Journal* 17: 238.

APPENDIX A

CHRONOLOGY AND IMPORTANT DATES

This thesis follows the basic chronology set in the *Oxford History of Ancient Egypt* (Shaw, 2000), though some dates are adapted to reflect recent evidence. Overlapping dates are intentional and reflect indistinct changes between rulers.

<u>Pre-Dynastic Period (Upper Egypt only)</u>	c. 5300-3000 B.C.
Badarian Period	c. 4400-4000 B.C.
Amratian (Naqada I) Period	c. 4000-3500 B.C.
Gerzean (Naqada II) Period	c. 3500-3100 B.C.
Dynasty "0" (Naqada III Period)	c. 3200-3000 B.C.
<u>Early Dynastic Period</u>	c. 3000-2686 B.C.
1st Dynasty	c. 3000-2890
2nd Dynasty	c. 2890-2686
<u>Old Kingdom</u>	2686-2160 B.C.
3rd Dynasty	2686-2613
4th Dynasty	2613-2494
Khufu (Cheops)	2589-2566
5th Dynasty	2494-2345
6th Dynasty	2345-2181
7th and 8th Dynasties	2181-2160
<u>First Intermediate Period</u>	2160-2055 B.C.
9th and 10th Dynasties	2160-2025
11th Dynasty (Thebes only)	2125-2055
Intef III	2063-2055
<u>Middle Kingdom</u>	2055-1650 B.C.
11th Dynasty (Rest of Egypt)	2055-1985
Mentuhotep II	2055-2004
Mentuhotep III	2004-1992
Mentuhotep IV	1992-1985
12th Dynasty	1985-1773
Amenemhat I (Sehetepibre)	1985-1956
Senwosret I (Kheperkare)	1956-1911
Amenemhat II (Nubkaure)	1911-1877
Senwosret II (Khakheperre)	1877-1870
Senwosret III (Khakaure)	1870-1831
Amenemhat III (Nimaatra)	1831-1786
Amenemhat IV (Maakherura)	1786-1777

Queen Sobekneferu (Sobekkara)	1777-1773
13th Dynasty	1773-1650
<u>Second Intermediate Period</u>	<u>1650-1550 B.C.</u>
14th Dynasty	1655-1645
15th Dynasty	1650-1550
16th Dynasty (Thebes)	1650-1580
17th Dynasty	c. 1580-1550
<u>New Kingdom</u>	<u>1550-1069 B.C.</u>
18th Dynasty	1550-1295
Included:	
Thutmose I	
Queen Hatshepsut	
Amenhotep IV (Akhenaten)	
Tutankhamun	
19th Dynasty	1295-1186
Included:	
Ramses I	
Sety I	
Ramses II	
20th Dynasty	1186-1069
Included:	
Ramses III - XI	
<u>Third Intermediate Period</u>	<u>1069-664 B.C.</u>
21st Dynasty	1069-945
22nd Dynasty	945-715
23rd Dynasty	818-715
24th Dynasty	727-715
25th Dynasty	747-656
<u>Late Period</u>	<u>664-332 B.C.</u>
26th Dynasty	664-525
27th Dynasty (1st Persian Period)	525-404
28th Dynasty	404-399
29th Dynasty	399-380
30th Dynasty	380-343
2nd Persian Period	343-332
<u>Ptolemaic Period</u>	<u>332-30 B.C.</u>
<u>Roman Period</u>	<u>30 B.C. - A.D. 395</u>

APPENDIX B

LINE TRANSLATION OF SELECT PAGES IN *FOUILLES À DÂHCHOUR* (1895)²⁰¹

Excavations at Dahshur
By J.J. de Morgan

p. 81-82 *Excavations at Dahshur*

I had hoped to discover the entrance to the underground passages in the wall of the pyramid and remembering its position in the pyramids of Illahoun, I pushed the action toward the south. This expectation was not fulfilled so I crossed the southern wall and started digging to the south-west.

While carrying out these surveys I discovered an immense vaulted room (fig. 201-202) made of bricks and walled in at the two ends, which until now I could not guess the purpose. This remarkable construction which, by its appearance and its building materials belonged to the Middle Kingdom, had been buried beneath an enormous pile of rubble and debris from large monuments which had formerly been raised on this presently deserted plateau. (See XXVIII.)

The strangeness of this construction induced me to carefully explore it. In proceeding with the excavations though four and five meters of debris I uncovered three small boats of ten meters in length, of which two are located in the Gizèh Museum today (fig. 203). Three other similar small boats were found in the sand about 100 meters south of the first set. Then some wooden sleighs were found, although at this point the excavations were not finished everything lead me to believe that we will still find a good number of small boats and sleighs. These boats had been deposited on the diluvium gravels, held up on the sides with the help of unbaked mud bricks and buried beneath the rubble. Their rudders were placed lengthwise on the deck.

The construction of these boats is remarkable: we do not see their interior decorated with framing as is customary to do today with modern boats, but the various planks are fixed securely—one on the other—with tenons in the middle of mortises that are in the thickness of the wood. (See XXIX, XXX, and XXXI).

This mode of construction seems to have been very solid because around 5000 years after they were made the two small boats extricated from the surrounding rubble and supporting bricks were still holding perfectly rigid. In order to transport them without risk, I constructed a wood casing around each one. Seventy porters could carry this mass of wood to the Nile over a distance of about eight kilometers.

p. 83 *Excavations at Dahshur*

One of the two boats in the Gizèh Museum was painted in white, the other in red, both, just as the blades of their rudders, bore multicolor embellishments. The three others stayed in place buried under the sand. Time did not permit me to remove them.

What was the use of these boats? How was it that we found them in the middle of the desert? We thought that they served as transports for royal mummies. The sleighs found nearby lying buried in the rubble seem to prove that our opinion is the only acceptable one.

²⁰¹ Barden, A., and P.P. Creasman. 2004. *English Translation of 'Fouilles à Dâhchour: Mars-Juin 1894' by J.J. de Morgan*. http://imrd.org/digitalexhibit/dahshur_currentresearch/fouilles1895translation.htm (1 March 2005).

APPENDIX C

THE TURIN CANON

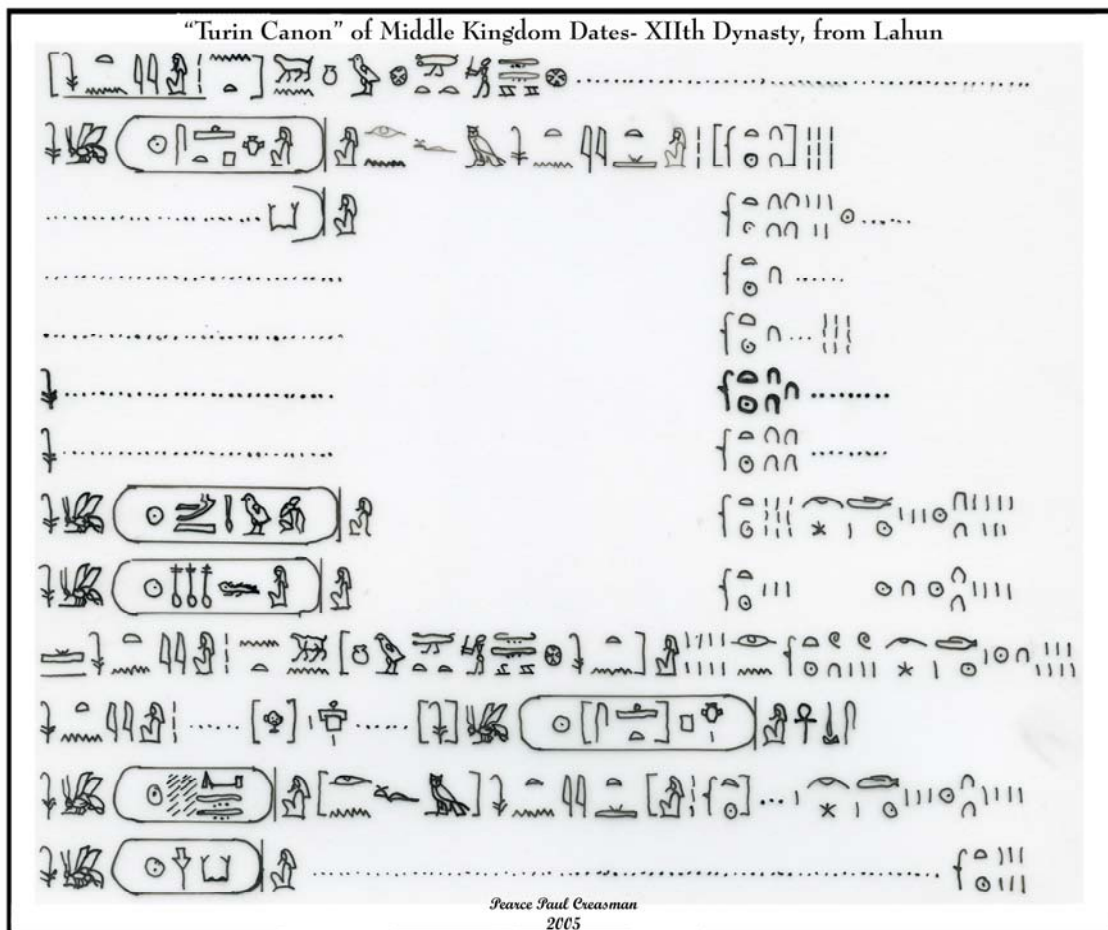

Translation after Griffith (1898, 85);

...more papyrus above...

(12th Dynasty)

[Kings in] residence at Athtau

King SehetepabRe passed in reigning [2]9 years

[King NubkauRe] passed in reigning 45 years

[King KheperkaRe] passed in reigning [1]9 years

[King KhahauRe] passed in reigning 30 + x years

[King NemaatRe] passed in reigning 40 + x years

King MaakheruRe passed in reigning 9 years 3 months 27 days

King SebekneferuRe passed in reigning 3 years 10 months 24 days

[The total] kings at Residence [of Athtau] 8 [kings] makes 213 years 1 month 17 days.

(13th Dynasty)

Kings that [came/ruled] after [the children?] of King SehetepabRe

King [Skhem] KhutauRe [passed in] reigning 1 + x years 3 months 24 days

...papyrus continues...

APPENDIX D

THE ROYAL TITULARY OF SENWOSRET III

During the Middle Kingdom the pharaohs had up to five official names, called the Royal Titulary, which corresponded to various official, spiritual, and familial relationships. Unfortunately, it is rare that all of the names of any pharaoh are preserved and this widely contributes to the difficulty of establishing an accurate chronology. The names were the *Nomen*—the name given at birth that is effectively a pharaoh's 'real' name; the *Praenomen* or "throne name"—ceremonial in nature and in most cases paid tribute to an ancestor and a god; the *Horus* or *Ka* name—paid tribute and implied the embodiment of the god Horus on earth (the Pharaoh as a god) but by the beginning of the Middle Kingdom was being replaced in importance by the throne name; the *Nebti* name—honored the serpent goddess Nekhbet (Upper Egypt) and cobra goddess Uto (Lower Egypt), and symbolized the union of the two lands; finally, the *golden Horus* name—the implication of this name is the subject of considerable debate, but it seems to have been used to ensure an eternal bond with Horus (and eternal life), or it was a name given for victory over an enemy.

Since the late 18th century A.D., and more specifically since 1822 when Jean-Francis Champollion²⁰² was credited for the decipherment of hieroglyphs using the Rosetta Stone, scholars have confused, mistranslated, and constantly re-named almost every pharaoh. Name turnover of the pharaohs was mostly due to the rapid advancements in understanding Egyptian texts, to undetermined number of names used for each pharaoh, and to an initially slow understanding of the systems and mores of the ancient Egyptians.

As discussed in this thesis, Senwosret III was a powerful and well-known ruler, which probably contributed to the confusion of his names. Rarely is he referred to by the same name by various authors; for some authors his name differs with each publication. This practice can become problematic for researchers and scholars conducting research if they are not familiar with all the possible combinations of a single persons' name. This appendix hopes to provide some clarity regarding the names of Senwosret III. While this section aspires to be comprehensive it is likely that other names or versions of names have escaped my research.

Only two names are know for Senwosret III: "Khakaure" and several forms of "Senwosret," namely his *Nomen* and *Praenomen*. Below, several versions and their origin are given, with the cartouche when possible. Alternate spellings are in parentheses.

²⁰² In his "Lettre à M. Dacier relative à l'alphabet des hiéroglyphes phonétiques," delivered to the Académies des Inscriptions. Two years later, in 1824, Champollion published an in-depth work on the decipherment of hieroglyphs titled *Précis du système hiéroglyphique*.

Khakaure (Khakaura) - "Son of Ra" name; *Nomen*.



Sesostris (Sestrosis) - Ancient Greek mythic hero figure; name used by Manetho.

Ousertesen III - As labeled by excavator J.J. de Morgan in his report, routed in French translation of the Greek.

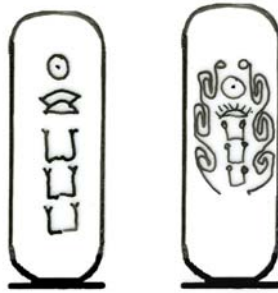

Sesostris (Sestrosis) III - Greek. Used late 19th to mid 20th century A.D.



Senusret III (Senusert) - From the hieroglyphs, generally used in British-English. The alternate is a common misspelling.

Senwosret III (Senwusret) III - Americanized form from British-English and hieroglyphs.



APPENDIX E

BENI HASSAN, TOMB 2/ MAIN ROOM, EAST WALL

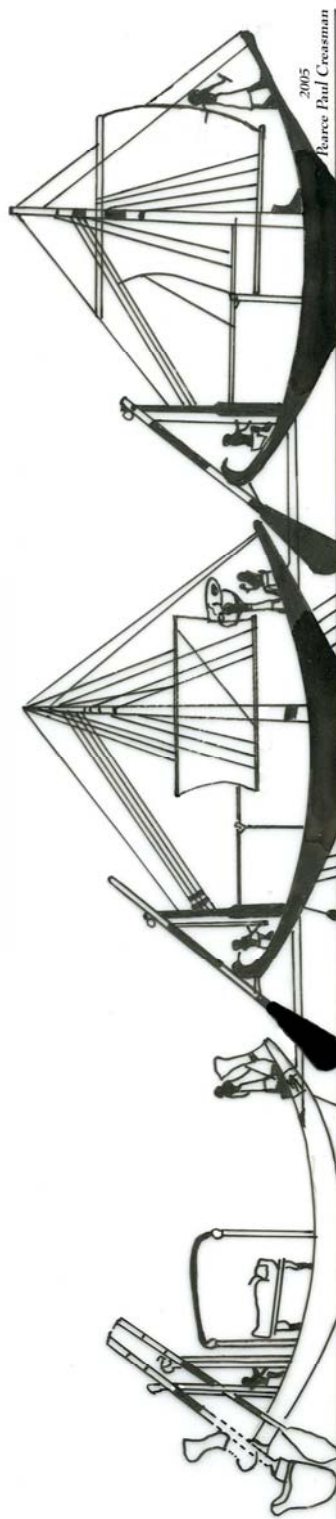

2005
Pearce Paul Creasman

APPENDIX F

TABLE OF DECK PLANK MEASUREMENTS FROM GC 4926

Length, width and thickness measured in meters.

	Length	Width	Thickness	# of Pegs	# Mortise-&-Tenon Joints
Section 1					
a	0.43	0.11	0.03	3	0
b	0.77	0.27	0.03	2	0
c	0.50	0.14	0.028	2	0
Section 2					
a	0.68	0.15	0.04	1	1
b	0.68	0.27	0.022	0	2
c	0.67	0.21	0.33	0	2
d	0.65	0.13	0.25	0	0
Section 3					
a	0.70	0.09	0.03	0	0
b	0.73	0.21	0.035	0	1
c	0.70	0.11	0.03	0	0
d	0.72	0.14	0.03	2	0
e	0.70	0.18	0.03	2	0
f	0.70	0.21	0.03	0	1
g	0.72	0.09	0.03	0	2
Section 4					
a	0.69	0.15	0.035	0	2
b	0.71	0.17	0.025	0	0
c	0.70	0.34	0.025	3	2
d	0.70	0.22	0.03	0	2
e	0.69	0.10	0.03	1	2
f	0.70	0.25	0.03	0	4
g	0.70	0.21	0.025	0	0
Section 5					
a	0.70	0.23	0.03	1	1
b	0.70	0.22	0.03	0	1
c	0.70	0.16	0.04	0	2

Appendix F continued

	<u>Length</u>	<u>Width</u>	<u>Thickness</u>	<u># of Pegs</u>	<u># Mortise-&-Tenon Joints</u>
d	0.70	0.12	0.03	0	2
e	0.70	0.13	0.03	0	1
f	0.70	0.25	0.03	0	1
g	0.70	0.24	0.03	2	3
h	0.69	0.21	0.035	0	3
Section 6					
a	0.68	0.21	0.028	0	1
b	0.68	0.20	0.03	0	1
c	0.69	0.20	0.025	1	0
d	0.66	0.15	0.03	1	0
e	0.69	0.27	0.03	0	1
Section 7					
a	0.72	0.13	0.03	0	0
b	0.72	0.15	0.03	0	1
c	0.72	0.12	0.03	0	1
d	0.69	0.35	0.035	0	1
e	0.72	0.05	0.025	0	0
f	0.72	0.09	0.025	0	1
g	0.72	0.22	0.03	0	3
Section 8					
a	0.67	0.22	0.03	0	1
b	0.67	0.15	0.025	0	2
c	0.64	0.09	0.03	0	2
d	0.68	0.08	0.04	0	1
e	0.69	0.05	0.04	0	1
f	0.69	0.15	0.03	0	1
g*	0.69	0.23	0.03	1	0
h	0.68	0.25	0.035	0	2
i	0.68	0.15	0.03	0	0
j	0.69	0.18	0.03	0	0
k*	0.68	0.17	0.035	1	0
Section 9					
a	0.64	0.23	0.025	0	0
b	0.68	0.16	0.03	0	3

Appendix F continued

	Length	Width	Thickness	# of Pegs	# Mortise-&-Tenon Joints
c	0.66	0.21	0.03	0	1
d	0.71	0.20	0.035	1	1
e	0.69	0.23	0.025	0	2
f	0.69	0.11	0.03	1	1
g	0.70	0.13	0.02	0	2
h	0.70	0.21	0.02	0	3
i	0.70	0.25	0.025	0	0
Section 10					
a	0.67	0.17	0.025	0	1
b *	0.70	0.23	0.03	0	5
c	0.72	0.19	0.035	0	3
d	0.71	0.17	0.035	0	2
e*	0.72	0.21	0.04	1	1
f	0.73	0.18	0.04	0	2
Section 11					
a	0.65	0.14	0.03	0	1
b	0.69	0.23	0.03	0	1
c	0.65	0.24	0.033	0	0
d	0.66	0.11	0.028	0	1
e	0.69	0.12	0.02	0	0
f	0.91	0.14	0.02	0	0
Section 12					
a	1.01	0.24	0.035	2	4
b	0.77	0.21	0.035	7	3

* Notes the presence of a 2.5 cm square hole intentionally cut through the plank, probably ancient.

VITA

Name: Pearce Paul Creasman

Address: 10105 Newbys Bridge Road, Chesterfield, VA 23832

Email Address: p.creasman@tamu.edu

Education: B.A., Anthropology; Philosophy; Concentration in Classical Studies, The University of Maine, 2003.
M.A., Anthropology (Nautical Archaeology), Texas A&M University, 2005.

Experience: September 2004- Present: Graduate Research/Teaching Assistant, Nautical Archaeology Program, Department of Anthropology, Texas A&M University.
December 2003- Present: Director, The Cairo Dahshur Boats Project. The Egyptian Museum, Cairo.
September 2001- January 2003: President of the Student Body (The University of Maine); CEO, Student Government Inc.

Grants and Awards: Eagle Scout
World Junior Champion- Triathlon
Phi Sigma Tau
Golden Key Honor Society
The MSC L.T. Jordan Institute for International Awareness, Fellowship
The Melbern G. Glasscock Center for Humanities Research, Fellowship
The Institute of Nautical Archaeology, Scholarship
Work Merit Scholarship (University of Maine)